

Dimplex[®]

2kW Ceramic Heater with Wi-Fi

Model: DHCER20WIFI

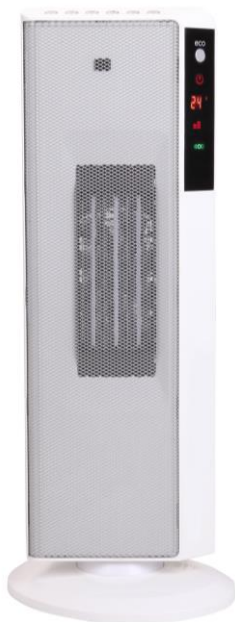

INSTRUCTION MANUAL

PLEASE READ THE INSTRUCTION MANUAL CAREFULLY BEFORE USING THE UNIT

TABLE OF CONTENTS

WARNINGS AND PRECAUTIONS.....	1
STRUCTURE	3
OPERATION.....	4
CLEANING AND MAINTENANCE	10
TECHNICAL REFERENCE DATA	12
WARRANTY	12

WARNINGS AND PRECAUTIONS

Warnings

- Never place the unit near gas appliances, flames or flammable liquids.
- Never hit or shake the unit. Doing so may cause damage.
- Never cover or obstruct the air inlet or outlet. Doing so may cause overheating.
- Never spray water on or place the unit near water. Doing so may cause electric shock.
- Never connect other appliances to the same power outlet.
- Never connect or disconnect the power plug with wet hands. Doing so may cause electric shock.
- Never insert fingers or objects through the guards when the unit is operating.
- Never use an extension cord.
- Always have a professional technician, manufacturer or service agent replace a damaged power cord.

Precautions

- This appliance is for indoor use only.
- Do not use the unit near windows or where water collects. Rain and water collection may lead to a risk of fire or electric shock.
- Do not place the unit in a damp place or where humidity is high (such as a bathroom).
- Do not leave the unit operating while unattended.
- Do not place the unit in direct sunlight to avoid surface discolouration.

- This appliance is not intended for use by persons (including children) with reduced physical, sensory or mental capabilities, or lack of experience and knowledge, unless they have been given supervision or instruction concerning use of the appliance by a person responsible for their safety.
- Children should be supervised to ensure they do not play with the appliance.
- Avoid electromagnetic interference. Keep the unit at least 1 metre away from electric appliances such as televisions and radios.
- Avoid scratching and damaging the surface. Do not use chemical solvents (i.e. Benzene, alcohol) to clean the surface.
- Place the unit on a stable surface when operating.
- Unplug the unit before cleaning, servicing or maintenance.
- Electrical connections must be in accordance with National or Local Codes.
- The rear of the unit must be at least 50cm away from the wall.
- Do not place the appliance on its side, back or front while in storage or transport. The unit must be left in an upright position 2 hours before operation.
- If the supply cord is damaged, it must be replaced by the manufacturer, its service agent or similarly qualified persons in order to avoid a hazard.
- **WARNING:** do not cover the heater. This may cause the unit to overheat.
- Do not use the heater in the immediate surroundings of bathtubs, showers, washing stands or swimming pools.
- The heater must not be located immediately below a socket-outlet.

STRUCTURE

1. Buttons
2. Eco button
3. Display panel
4. Front cover
5. Front grille
6. Oscillating base
7. Base
8. Wi-Fi button
9. Back grille
10. On/Off switch
11. Power cord

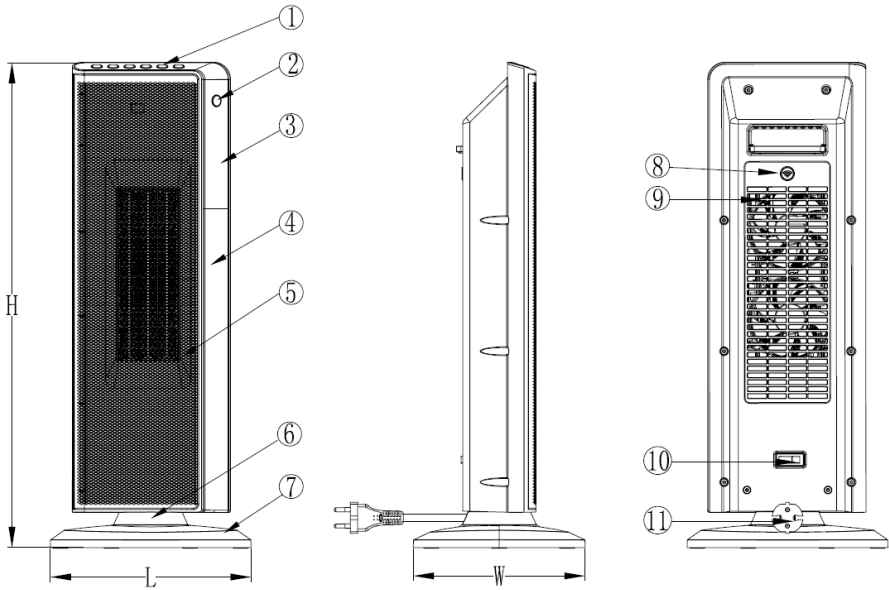

OPERATION

DISPLAY PANEL



Power indicator



ECO function indicator



Wi-Fi indicator



Low power indicator



Temperature indicator



Timer indicator



Swing indicator



High power indicator

CONTROL PANEL

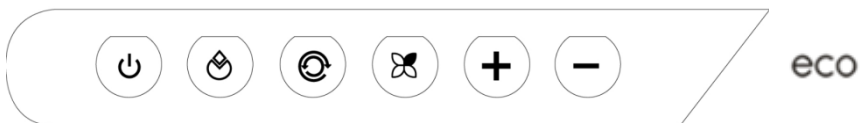

REMOTE CONTROL



 ON/OFF button

 Low / High Power button

 ECO button

 Timer/Temperature button

 + - Timer/Temperature set button

 Swing button

ON / OFF

This button is used to switch the unit ON and OFF.

TIMER

A timer can be set so the unit turns off automatically after a set period.

When Pressing the TIMER button once, the 'h' indicator will illuminate. Press the '+/-' button to set the timer between 0-12 hours. Each press of the '+/-' button increases/decreases the set time in 1 hour increments. If a time isn't set within 5 seconds, the unit will exit the timer function and revert to displaying the room temperature.

LOW / HIGH POWER

By simply pressing this button, you can regulate the mode from LOW Power to HIGH Power depending on your needs. The unit automatically starts in LOW Power mode.

SWING

The unit will begin to oscillate after pressing the SWING button, the indicator light will illuminate. To turn off the SWING function, press the swing button again, and the swing will stop and the indicator light will switch off.

ECO MODE

When ECO Mode is selected, the unit will automatically adjust to suitable settings according to the room temperature. When the room temperature is below 18°C, the unit will operate in HIGH Power, and when the room is above 18°C, the machine will operate in LOW Power. When the room reaches 22°C the unit will stop working, until the room temperature decreases, and will resume working again.

WI-FI

You can operate the unit wirelessly when connected to Wi-Fi. You'll need a Wi-Fi connection, and mobile device with the Dimplex CONNECT IT app installed.

1. Connect mobile device to Wi-Fi and download the Dimplex CONNECT IT app from the App Store, or Google Play.
2. Once installed, launch the app.
3. Press and hold the Wi-Fi button at the back of the unit (8) until the Wi-Fi indicator light flashes rapidly
4. Click 'Add the new device'. The SSID should automatically pick up the Wi-Fi connection name.
5. Enter the Wi-Fi password '123456' and hit connect.
6. Once connected you can control the unit via your mobile device and with a 3G or 4G network connection.

You can update the device name & password by following the steps below:

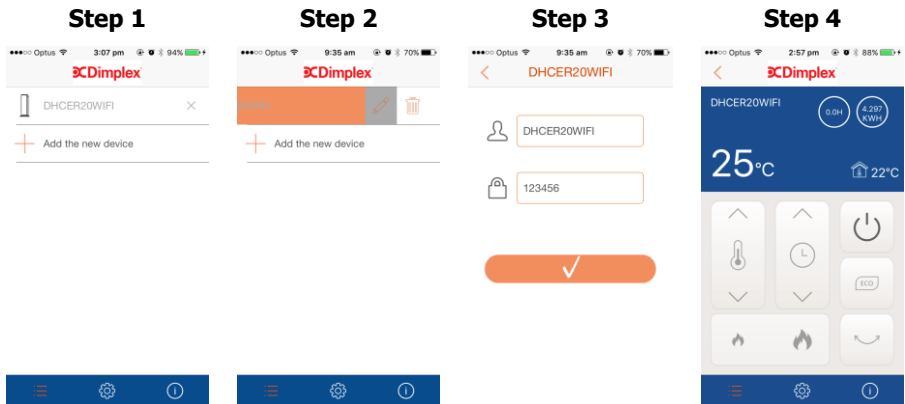

The connected device appears in the home screen. You can change the model name & update the password from this screen.

For Android – press & hold the model number to edit.
For iPhone – swipe left on the model number until you see the above change.

Rename the above fields to desired name / password and submit.

The new device name will appear in the top left hand corner in the control panel screen.

**If you need to change Wi-Fi networks, press the Wi-Fi button at the back of the unit (8), which will restore to factory settings. Then follow the steps above to connect to a new network.*

REMOTE CONTROL

The remote control can be used to operate all functions.

1. Remove the battery cover at the back of remote control (Picture 2).
2. Insert the battery (included) [Picture 3].
3. Replace the battery cover.

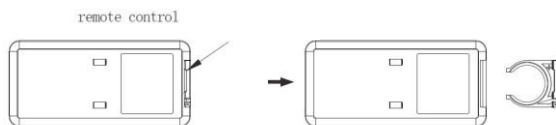

(Picture 2)

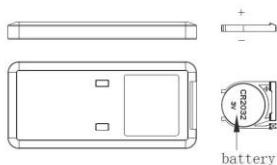

(Picture 3)

Operation

1. Connect the unit to a power supply and switch on.
2. The unit will be in standby mode and sound a 'beep beep' once connected to the power supply. The ON/OFF indicator light will illuminate.
3. Press the ON/OFF button to turn the unit ON.
4. The unit defaults to: Low Power, no swing and a temperature setting of 25°C.
5. Press the LOW / HIGH POWER button to change from Low Power to High Power.
6. Press the ECO button to put the unit into ECO Mode.
7. Press the TIMER button once, to set a time for the unit to turn off automatically. The number will flash on the LED display when the

time is ready to be set. Time is set in 1 hour increments, and can be set up to 12 hours. Press the '+/-' buttons to set the desired time.

8. Press the timer/temperature set button twice to set the temperature. The numbers will flash on the LED display when the temperature is ready to be set. The temperature can be set between 5-35°C. Press the '+/-' buttons to set the desired time.
9. Press the SWING button to activate oscillation mode. Press again to deactivate this mode.
10. Press the ON/OFF button to turn the unit off. It will take approx. 10 seconds for the fan to turn off and enter standby mode.

CLEANING AND MAINTENANCE

Cleaning

Pushing the unit up against a wall or operating it in close proximity to long window drapes will also impair the unit's air flow and efficiency.

1. Disconnect the appliance from the main supply and allow to completely cool down.
2. Use a soft cloth to wipe any dust from the heaters surface. If the surface is too dirty, use warm soapy water and a soft cloth to clean. Do not use solvents or abrasive products.
3. If storing the heater, ensure it has completely cooled down, is dry and packed away in a cool dry place.

IMPORTANT

The control panel must not come into contact with water or any other liquids.



- Do not dispose of electrical appliances as unsorted municipal waste. Use separate collection facilities.
- Contact your local government for information regarding the collection systems available.
- If electrical appliances are disposed of in landfills or dumps, hazardous substances can leak into the ground water, polluting the food chain and damaging health and well-being.

Maintenance

If the unit fails to operate efficiently, is broken or other problems arise, unplug and do not operate.

Ask for advice by calling your local after sales service agent or the Customer Care Centre on 1300 556 816 (AU) / 0800 666 2824 (NZ).

TECHNICAL REFERENCE DATA

Model		DHCER20WIFI
Rated Power		2000W
Voltage/Frequency		220-240V/50Hz
Net Weight		2.36kg
Dimensions HxWxD	Body (mm)	564 x 233 x 199
		

WARRANTY

The warranty period is 12 months from the date of purchase. For service advice, please contact the Customer Care Centre on 1300 556 816 (AU) / 0800 666 2824 (NZ).

Glen Dimplex Australia Pty Ltd

1340 Ferntree Gully Road,

Scoresby 3179, Victoria

Australia

Ph: 1300 556 816

Glen Dimplex Australasia Ltd

38 Harris Road, East Tamaki,

Auckland 2013

New Zealand

Ph: 0800 666 2824