



ELECTRIC BLANKET INSTRUCTIONS

**Fitted Quilt
Cotton Case / Polyester Filled
Detachable 12 hour Auto Off Controller**

Model Numbers

**DHEBPTS Single
DHEBPTQ Queen
DHEBPTK King**

Note: The specifications and/or components of this product are subject to change without prior notice

1	IMPORTANT SAFEGUARDS.....	3
2	Connecting the Controller.....	5
3	Securing Your Electric Blanket.....	6
4	Using The Controller	7
4.1	Electrical Field Effect.....	7
4.2	Auto Off.....	8
4.3	Pre Heat	8
5	Overheat / Element Protection.....	8
6	Recommended Cleaning Instructions.....	9
6.1	Treatment For Localised Soiling	10
6.2	Hand Washing (Recommended).....	10
6.3	Machine Washing.....	10
6.4	Drying	11
7	Servicing Your Blanket and Controller/s	11
8	Storage	11
9	Troubleshooting	12
9.1	Testing Controllers.....	12
9.2	Troubleshooting Table	13
10	Warranty	14

Important Instructions: Retain for future use.

Thank you for purchasing our Electric Blanket. Each unit is manufactured to ensure safety and reliability. Before using for the first time, please read the instruction manual carefully and keep it for future reference.

1 IMPORTANT SAFEGUARDS

- Before connecting and switching on the blanket, ensure that the voltage indicated on the rating label corresponds to the mains voltage in your home.
- Do not plug into a powerboard, double adaptor or the like. The power plug must be inserted directly into the wall power socket.
- Read the instructions carefully, in conjunction with the illustrations, before fitting the blanket and using for the first time.
- If the cord of this blanket is damaged, unplug and discontinue use of the product then contact the manufacturer.
- Check daily that your blanket is flat, fully spread out and secured before switching it on.

Failure to observe these instructions will result in overheating. This will activate the overheat safeguard system, thus leaving the blanket inoperative.

Misuse of this blanket will invalidate your warranty.

- Use as an under-blanket only.
- These blankets are not recommended for futons.
- When storing the blanket, allow it to cool down before folding. Fold neatly but not tightly (or rolled) without sharp bends in the heating elements and store where no other heavy objects will be placed upon it.
- The blanket should not be used on an adjustable bed. However, if the blanket is used on an adjustable bed, check that the blanket and cord do not become trapped or rucked, for example, in hinges.
- The Blanket is Not to be used by very young children (0-3 years)
- The Blanket is not to be used by young children over the age of three unless the controls have been pre-set by a parent or guardian, or unless the child has been adequately instructed on how to operate the controls safely.
- This Blanket is not intended for use by persons (including children) with reduced physical, sensory or mental capabilities, or lack of experience and knowledge, unless they have been given supervision or instruction concerning use of the appliance by a person responsible for their safety.
- This Blanket must not be used by persons insensitive to heat and other very vulnerable persons who are unable to react to overheating.
- Make sure that the heating area (on any side of the bed) does not fall over the edge of the mattress, that the attachments are adequate and suited to the mattress, and that the instructions are read before using the blanket.
- This blanket is not intended for use by young children or infirm persons without adequate supervision.
- Electric Blankets are intended for human use only. Not for animals and pets.



- Do Not Allow Pets or Animals To Lie or Chew On This Product or On The Electrical Cords Etc.
- Prolonged application at the highest heat setting can result in skin burns.
- Do not tuck the edges of the blanket in.
- Do not use the blanket rucked (creased) or folded.
- Keep the control away from an open window.
- Keep the controller/s away from external heat sources. i.e. a heater, fire place etc.
- Do not use pins as these may damage the electric wiring.
- Be sure that this blanket is used only on an alternating current supply circuit of the correct voltage. Refer to the rating label for specifications. (Foot end of the blanket)
- The flexible supply cord and switch must, as far as practicable, be kept outside of the bed covers.
- Do not switch the power on if the blanket is wet or in a folded or creased state.
- Switch off at the power outlet and remove the plug from the mains when the blanket is not in use.
- Bed clothes should not be folded back when the blanket is switched on.
- Do not leave heavy objects on the bed, e.g. folded blankets, suitcases etc. when the blanket is switched on as this will trigger the over temperature device and render the Blanket PERMANENTLY inoperable. This may also invalidate the warranty.
- Arrange the blanket so that the elements are not under the pillows and/or bolsters.
- Do not dry-clean this blanket. Cleaning liquid may have a damaging effect on the insulation covering of the heating element. Follow washing directions located on the blankets rating label. (Foot end of the blanket) and in this Instruction Manual.
- Persons suffering from bed-wetting should not use this blanket.
- If any abnormality or defect in operation is observed, discontinue its use immediately and consult the distributor regarding its examination and/or repair.
- The blanket should be examined frequently for signs of wear, either of the blanket, controller or flexible cord. If wear is visible or if any abnormality or defect in operation in the blanket is observed, discontinue use immediately and consult a qualified and registered person for service.
- The blanket must not be used over or under a water bed.
- Depending on the controller type, you may notice a blue flash in the switch when moving from one setting to another. This is NOT dangerous and is caused by the copper parts making contact.
- It is recommended that your electric blanket is inspected by a qualified and registered person after 3 years of use.
- This blanket is for domestic use only. It is **not** intended for use in hospitals or the like.

- Only use the controllers supplied with this blanket.
- For additional protection, it is strongly recommend that the use of a residual current device (RCD) with a tripping current not exceeding 30mA be used on the circuit supplying this product. If you are unsure if your home has this device, please contact your nearest Electrical Contractor.
- Always treat Electrical Appliances with the upmost care. Do not use this product in any other fashion or for any other purpose other than stated in these instructions.

2 Connecting the Controller

Turn Off Power and Remove the Plug from the Power Source

- To fit the controller plug, simply hold the socket with one hand and push the controller plug all the way until the locking tab locates over the lug on top of the controller plug.
- To remove the controller, lift the locking tab up with your finger and pull the controller plug directly out. Do Not Pull the controller cable and Do Not try and pull the controller plug out without lifting the locking tab as you will damage the socket.

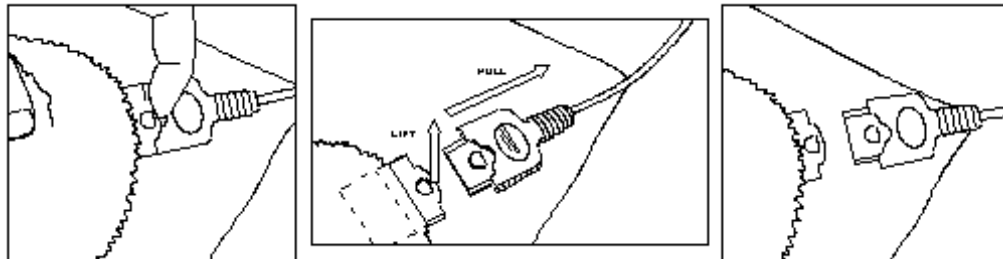

- Do Not fold, roll or kink the cable. Allow the cable to hang freely.
- Ensure the cable is not pulled so tight that it bends hard at the blanket connector end.

NOTE: Ensure that the electric blanket is sized to suit your mattress i.e. queen sized electric blanket must be used on a queen sized mattress.

Do not use a single bed blanket on a Double, Queen or King size mattress. The blanket top must not hang over the edges of the mattress.

3 Securing Your Electric Blanket

Note: Your electric blanket must be placed directly onto the mattress.

If using a mattress protector, this goes over the electric blanket.

IMPORTANT:

- Place the blanket onto the mattress with the controller connection/s at the **HEAD END** of the bed.

NOTE: Electric blankets **MUST NOT be used** on top of the user (as with a normal blanket), instead they must be firmly secured to the mattress.

- Fit the side skirts around the edges of the mattress then use the elastic skirt to ensure that the blanket fits snugly around the sides and underneath the mattress.
- Spread the skirt around the mattress edge ensuring even tension and making sure the blanket is placed evenly over the mattress then ensure that the blanket is flat and crease free.

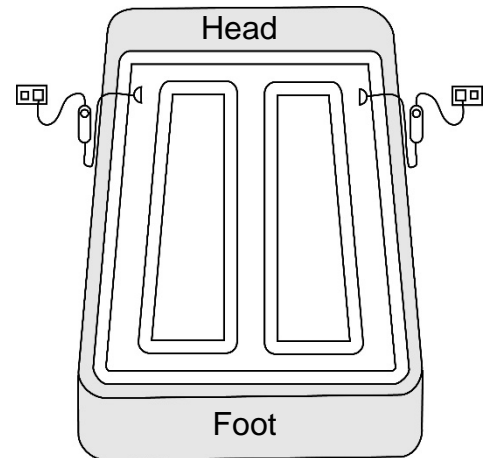

FAILURE TO FOLLOW THESE FITTING INSTRUCTIONS MAY TRIGGER THE OVERHEAT PROTECTION SYSTEM AND RENDER THE BLANKET PERMANENTLY INOPERATIVE. THIS MAY INVALIDATE THE WARRANTY.

Note: Care should also be taken if you are using a continental quilt because heat will build up more quickly than with other bed coverings. A short period may only be needed to reach maximum temperature depending on the insulation density of your quilt. This also applies if using additional bed blankets.

- The electric blanket should not be tucked in at the sides.
- Make your bed in the usual manner.
- After the blanket is secure and fitted correctly, plug the controller/s into the wall power socket and turn on.

NOTE: Do not plug into a powerboard, double adaptor or the like. The power plug must be inserted directly into the wall power socket.

IMPORTANT: DO NOT COVER THE CONTROLLERS AT ANY TIME.

Keep the controllers away from external heat sources. i.e. a heater, fire place etc.

4 Using The Controller

- Use your Electric Blanket with Detachable Controller Model MC-102A Only.
- Do not use any other controller for this blanket.

0 = Off
1 = Low Heat (Suitable for all night use)
2 = Medium Heat
3 = High Heat (For preheating the bed only)
0 = Off

- To select the required heat setting, slide the “Temperature Select Slide Knob” up or down to your desired setting.
- The selected position will be indicated by lighting up the corresponding Red Light.

i.e. If Heat setting “1” is selected, 1 Light will illuminate.

If Heat setting “2” is selected, 2 Lights will illuminate.

If Heat setting “3” is selected, 3 Lights will illuminate.

If Heat setting “O” (Off) is selected (at either end of the slide) no lights will illuminate.

TURN OFF AND UNPLUG THE BLANKET WHEN NOT IN USE.

Keep the controller away from external heat sources. i.e. a heater, fire place etc.

4.1 Electrical Field Effect

When using the Blanket, some people may be susceptible to a tingling sensation when alone or when touching someone else using the Blanket.

This “Tingling” feeling is known as an “electric field effect” and is occasionally known to happen across all makes and brands of Blankets. It is caused by the current flowing through the element creating an Electromagnetic Field (EMF). Some people are more susceptible to feeling this EMF tingling sensation than others. This is no cause for concern and is in no way an electric shock.

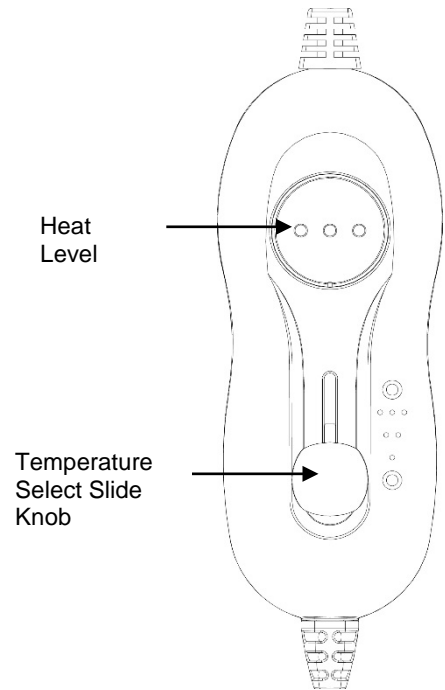

4.2 Auto Off

This controller is fitted with a 12 hour Count Down Auto Off Timer which starts to countdown from when your heat setting has been selected, and will switch power off to the elements after approximately 12 hours. (+/- 30Minutes).

Note: Once a heat setting has been selected and the switch is powered ON, the countdown timer will not be affected by adjusting heat level.

The timer will only be reset to 12 hours by sliding the control knob to heat level "O" or after being powered OFF and then back On.

When the controller has timed out, the element will turn off and the Red LED's on the front display will flash.

Slide the control knob to the "O" position to reset.

4.3 Pre Heat

The controller has a pre-heat facility in order for you to warm your bed prior to getting into it.

The time taken to pre-heat the bed will depend on the ambient temperature of the bedroom and whether an electric blanket has been used to air the bed on a regular basis.

At normal ambient temperature you should allow approximately 30 - 60 minutes on Heat Setting "3" (Pre Heat).

You may get into bed sooner while the bed is still warming up, but please **DO NOT** leave the blanket set on the Preheat setting (No. 3) while you are in the bed.

A cold room or bed that has not been used for some time may require a greater length of time on the pre-heat.

5 Overheat / Element Protection

- The blanket is fitted with numerous overheat safeguard systems. This offers protection against overheating or damage to the elements by disengaging the power to the elements before overheating hazards occur.
- Should there ever be a problem with the heating element in the Blanket, it will automatically close down the operation and the Blanket will turn off.
- **The controller must not be covered.** The controller has built in protection, so that if the controller overheats, or the heating element is damaged, it will automatically close down the operation Permanently.

- Should this occur, the Blanket and Front Heat Level display lights will turn off and a RED indicator light will illuminate through the back of the controller. This indicates that the Blanket and controller needs to be replaced and cannot be repaired.

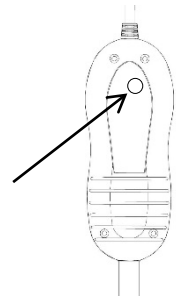

If in a bright room, you may need to cup your hands around the back of the controller to make it darker so that the RED indicator light can be seen.

NOTE: Keep the controller away from external heat sources. i.e. a heater, fire place etc.









Please refer to the Troubleshooting Guide in the back of this manual before calling the service department or before returning the Blanket.

6 Recommended Cleaning Instructions

DO NOT DRY CLEAN, DO NOT WRING, DO NOT SPIN DRY

Ensure all controllers are unplugged from the power point and from the electric blanket before cleaning.

Ensure the controller/s and plugs do not get wet.

<p>DO use only as an Underblanket. DO Secure Blanket to bed Properly before use. DO only clean this Blanket as specified in the instruction book. DO have this Blanket repaired and/or tested by an authorised Electrical agent. DO remove controller/s before washing Blanket. DO Turn Off and Unplug when Not in Use.</p>	<p> Do Not Bleach or use detergents with Bleach</p> <p> Do Not Iron</p> <p> Do Not Dry Clean</p> <p> Do Not Tumble Dry</p> <p> Hang on line only when excess water has been removed. Do Not Peg Wired Parts</p> <p> Do Not Spin Dry Do Not Wring</p> <p> Dry In Shade</p> <p> Machine Wash on Delicate Only or Hand Wash Only</p>
<p>DO NOT use as an Over Blanket. DO NOT use Tucked in, Folded, Rucked, Bunched Up or Creased. DO NOT use with Element or Wired parts Tucked in. DO NOT use if wet. DO NOT insert needles or pins into Blanket. DO NOT use with damaged element or cables. NOT TO be used by persons insensitive to heat and other very vulnerable persons who are unable to react to overheating. NOT TO be used by very young children. DO NOT wash controller/s. DO NOT cover controller/s.</p>	

6.1 Treatment For Localised Soiling

Never Use Hot Water as the blanket may shrink and will void your warranty.

The area affected should be sponged gently using a natural wool detergent or mild soap flakes dissolved in lukewarm water (30°C Max), followed by two consecutive spongings using clean, soap-free lukewarm water.

- Lightly compress the treated area between two towels to absorb excess water.

Do Not Wring or Spin Dry the Blanket.

- Refer to the section “**Drying**” for drying instructions.
- The connections to the blanket must be kept free of moisture.

6.2 Hand Washing (Recommended)

Never Use Hot Water as the blanket may shrink and will void your warranty.

- Place the Blanket in lukewarm (30°C Max) water (bathtub or large laundry tub is ideal) mixed with either a natural wool detergent or with mild soap flakes.
- Soak the blanket for approximately five minutes, and then gently squeeze the soapy water through.
- Rinse the blanket thoroughly with clean lukewarm water until no more suds are visible and allow water to drain off.
- Refer to the section “**Drying**” for drying instructions

With normal use it is recommended that you hand wash your blanket once a year.

Do Not Wring or Spin Dry the Blanket.

6.3 Machine Washing

- Place the Blanket in the washing machine with either a natural wool detergent or with mild soap flakes.
- Set your machine to the Delicate Wool or Gentle cycle (**without Spin Dry**) and set the water temperature to warm (30°C Max). **Do Not Wash With HOT Water.**
- When the cycle has finished, allow water to drain off.
- Refer to the section “**Drying**” for drying instructions

Do Not Wring the Blanket. Do Not Spin Dry.

6.4 Drying

- Spread the blanket out on a clean surface (e.g. a large table) to dry in a shady area.
- Your blanket can also be dried on a clothes line provided the blanket is not creased or folded.
- Ensure pegs are not used on the element areas of the blanket if hanging on the line.

Note: The blanket must be thoroughly dried including controller sockets before being re-fitted to your bed.

- With normal use it is recommended you hand wash your blanket once a year

Do Not Wring the Blanket. Do Not Spin Dry.

7 Servicing Your Blanket and Controller/s

NOTE: There are no user serviceable parts in this blanket or controller/s.

- The blanket should be examined frequently for signs of wear, either of the blanket, controller or flexible cord. If wear is visible or if any abnormality or defect in operation in the blanket is observed, discontinue use immediately and consult a qualified and registered person for service.
- It is recommended that your electric blanket is inspected by a qualified and registered person after 3 years of use.
- If the blanket is not operating correctly, please check the Troubleshooting Guide in the back of this manual before contacting our service department.

8 Storage

When storing the blanket, allow it to cool down before folding. Fold neatly (or rolled) but not tightly without sharp bends in the heating elements and store where no other heavy objects will be placed upon it.

Store in a dry place where it cannot be damaged.

9 Troubleshooting

9.1 Testing Controllers

Before contacting the service department please follow the steps below to determine if there is actually a fault, and if so, if a fault is within the blanket or within the controller. This will make it easier when talking to the service department.

Please also refer to the Troubleshooting Table on the next page for additional information prior to contacting the service department.

- Remove the “good” controller, which you know functions correctly from the other side of the blanket (excluding all single size blankets as these only have the one controller), and test it on the “trouble side” of the blanket to determine if it is the original controller or the blanket element which is at fault.

Please allow the “good” controller to be tested overnight as it may take a few hours for any fault to show up. It is possible that the “good” controller may function for a few hours prior to failing so it is important that the test be performed overnight and not just for a few minutes.

- If after the overnight test, the controller is still functioning (i.e. the lights on the front display are showing) and the blanket is heating properly, it can be concluded that the original controller is faulty.

If this is the case, please call the service department for a replacement controller. The model number of the controller is moulded into the back of the controller.

- If the “good” controller also stops functioning (No Lights on front display) during the overnight test, and the Red light is showing through the back of the controller (refer Overheat / Element Protection Section), it can be concluded that the blanket element has been permanently damaged during use.

If this is the case, ordering a new controller will not help as it is the damaged blanket element causing the safety devices in the controller to activate. The blanket and controllers cannot be repaired.

- If the “good” controller, when tested on the “Trouble Side” of the blanket is found to be still functioning properly (i.e. the lights on the front display are showing) after the overnight test, but the blanket is not heating, it can be concluded that the blanket element is faulty.

If this is the case, and if the blanket is still within the warranty period, please return the blanket to the retailer. If returning the blanket, we please ask that:

- The unit is packed carefully back into its original packaging.
- Original proof of purchase is attached.
- A brief note attached to the blanket explaining the reason why it is being returned.

9.2 Troubleshooting Table

Problem	Cause	Remedy
No Power to Controller / No Heat Level Indicator Lights showing on Front Display and No RED light showing through the back of the controller when a heat setting is selected	The Temperature Slide Knob is in the "O" position	Slide the knob to setting 1, 2 or 3. The corresponding front display Lights should illuminate.
	The Power Plug may not be plugged in to the power source and switched on.	Ensure the power plug is inserted into the power source correctly and switch on.
	There may be no power to the power point	Ensure there is power to the power point. Test with another appliance such as a table lamp.
No Heat Level Indicator Lights showing on Front Display when a heat setting is selected, however a RED indicator light is showing through the back of the controller.	The controller has overheated and blown the Over-Temp thermal fuse	The controller has overheated by means of an external heat source or the Blanket elements have been damaged. A new Blanket with controller must be purchased.
	The Blanket Elements have been damaged.	
Heat Level Indicator Lights showing on Front Display but Blanket is not heating	Detachable Plug from Controller to Blanket is not fitted correctly or has come loose.	Ensure the detachable plug is fitted correctly into the socket on the Blanket and the locking tab has clipped over the lug on the plug.
	The selected heat setting is too low.	Increase the Heat setting
	Bed Covers not pulled up over Electric Blanket	The electric blanket must be covered with the bed clothes / Doona. The Blanket will not feel warm if not covered while heating up. Do Not Cover the Controllers
	Pre-heat time is too short.	Allow the Blanket more time to heat up. More time is required depending on the ambient temperature.
Heat Level Indicator Lights showing on Front Display but cannot change any of the settings	Program may have locked up to protect itself due to a power surge.	Unplug the controller from the power point, wait 2 minutes and then plug in and switch on again.
Heat Level Indicator Lights Flashing on Front Display	The Auto Off timer has activated and turned off the blanket.	The Blanket Controller will automatically turn off after approximately 12 hours. Slide the knob to the "O" position to reset, wait 5 seconds, then select the desired heat setting again.
Controller is Warm to Touch	This is normal	Nothing to do. Is no cause for alarm.
Tingling Sensation when alone or when touching someone else lying on the blanket	<p>This "Tingling" feeling is known as an "electric field effect" and is occasionally known to happen across all makes and brands of electric blankets. It is caused by the current flowing through the element creating an Electromagnetic Field (EMF). Some people are more susceptible to feeling this EMF tingling sensation than others. This is no cause for concern and is in no way an electric shock.</p> <p>All blankets and controllers conform to IEC 62233 "electromagnetic fields of household appliances and similar apparatus with regard to human exposure" and are proven to be at least 14 times lower in EMF than the recommended limits in the standard.</p>	

10 Warranty

This warranty is provided by Glen Dimplex Australia Pty Limited ABN 69 118 275 460 of Unit 1, 21 Lionel Road, Mount Waverley, Victoria 3149 (Phone number 1300 556 816), or in New Zealand by Glen Dimplex Australasia Limited, New Zealand registration number 1506305, of 38 Harris Road, East Tamaki, Auckland, New Zealand (Phone number 09 2748265) (**we, us our**) in respect of the Dimplex product which this warranty card has been included in the packaging for or otherwise supplied with (**the Dimplex product**).

1 Dimplex express warranty

Subject to the exclusions below, we warrant that the Dimplex product will be free from defects caused by faulty workmanship and materials within:

- a) in the case of the Dimplex products used for personal, domestic or household purposes, a period of 24 months from the date the Dimplex product is purchased as a brand new product from a retailer located in Australia or New Zealand; and
- b) in the case of the Dimplex product used for purposes other than personal, domestic or household purposes (including business or commercial use), a period of 12 months from the date the Dimplex product is purchased as a brand new product from a retailer located in Australia or New Zealand. Dimplex products are designed and intended for domestic use.

This express warranty is personal to the first person who acquires the Dimplex product from the relevant retailer and claims under this warranty cannot be made by anyone other than this person.

The benefits conferred by this express warranty are in addition to the Consumer Guarantees referred to in section 3 and any other statutory rights you may have under the Australian Consumer Law, the New Zealand Consumer Guarantees Act and/or other applicable laws.

2 Warranty exclusions

This express warranty does not apply where:

- a) the Dimplex product has been installed, used or operated otherwise than in accordance with the product manual or other similar documentation provided to you with the Dimplex product;
- b) the Dimplex product requires repairs due to damage resulting from accident, misuse, incorrect installation, improper liquid spillage, cleaning or maintenance, unauthorised modification, use on an incorrect voltage, power surges and dips, voltage supply problems, tampering or unauthorised repairs by any persons, use of defective or incompatible accessories or exposure to abnormally corrosive conditions;

- c) the repair relates to the replacement of consumable parts such as fuses in plugs and bulbs or any other parts of the Dimplex product which require routine replacement;
- d) you are unable to provide us with reasonable proof of purchase for the Dimplex product;
- e) the breakdown occurs after the expiry of the express warranty period set out in section 1; or
- f) the Dimplex product was not purchased in Australia or New Zealand as a brand new product.

3 Consumer Guarantees

Our goods come with guarantees that cannot be excluded under the Australian Consumer Law. You are entitled to a replacement or refund for a major failure and for compensation for any other reasonably foreseeable loss or damage. You are also entitled to have the goods repaired or replaced if the goods fail to be of acceptable quality and the failure does not amount to a major failure.

If you acquired the goods in New Zealand, similar provisions of the Consumer Guarantees Act 1993 may apply, but may be excluded if you acquired the goods for the purpose of a business.

4 How to make a claim

You may make a claim under this warranty by visiting our website at (www.dimplex.com.au in Australia, www.dimplex.co.nz in New Zealand), contacting our customer care line (1300 556 816 in Australia, 09 274 8265 in New Zealand) or visiting a Dimplex service centre.

To make a valid claim under this warranty, you must:

- a) lodge the claim with us as soon as possible and no later than 14 days after you first become aware of the breakdown;
- b) provide us with the Dimplex product serial number;
- c) provide us with reasonable proof of purchase for the Dimplex product; and
- d) if required by us, provide us (or any person nominated by us) with access to the premises at which the Dimplex product is located at times nominated by us (so that we can inspect the Dimplex product).

5 Warranty claims

If you make a valid claim under this warranty and none of the exclusions set out in section 2 apply, we will, at our election, either repair the Dimplex product or replace the Dimplex product with a product of identical specification (or where the product is superseded or no longer in stock, with a product of as close a specification as possible).

Goods presented for repair may be replaced by refurbished goods of the same type rather than being repaired. Refurbished parts may be used to repair the goods. Dimplex products are designed and supplied for normal domestic use. We will not be liable to you under this warranty for business loss or damage of any kind whatsoever.

6 Costs of warranty claim

Where you make a claim under this warranty, a Dimplex authorised repairer may need to attend your premises to inspect the Dimplex product. If the Dimplex product is located in Australia, we may charge you a service call fee if a repairer will be required to travel more than 30 kilometers from the place of purchase. For further information, please contact Dimplex on 1300 556 816 in Australia or 09 274 8265 in New Zealand. Alternatively, visit our website at www.dimplex.com.au in Australia or www.dimplex.co.nz in New Zealand.

Glen Dimplex Australia Pty Ltd.

Unit 1, 21 Lionel Road.
Mount Waverley VIC 3149
Australia
Ph: 1300 556 816
Fax: 1800 058 900
Web: www.dimplex.com.au

Glen Dimplex New Zealand Ltd.

38 Harris Road, East Tamaki,
Manukau, Auckland 2013
New Zealand
Ph: (09) 274 8265
Fax: (09) 274 8472
Web: www.dimplex.co.nz

DISPOSAL



- Do not dispose of electrical appliances as unsorted municipal waste. Use separate collection facilities.
- Contact your local government for information regarding the collection systems available.
- If electrical appliances are disposed of in landfills or dumps, hazardous substances can leak into the ground water, polluting the food chain and damaging health and well-being.