

FROZEN DESSERT MAKER – KADSRTMKERA

Quick Start Guide

Important Safeguards

Basic safety precautions should always be followed when using electrical appliances, including the following:

- Read all instructions before operating this appliance.
- DO NOT touch moving parts. Never place fingers or other utensils into feed or discharge areas.
- To protect against electrical shock, do not immerse cord, plug or any other part of this appliance into water or other liquids.
- To avoid fire or shock hazards, or damage to the unit, this unit should only be plugged into a polarized Australian/New Zealand 220-240V AC outlet.
- DO NOT operate any appliance with a damaged cord or plug, or if the appliance has been damaged in any manner. Contact the Kogan customer support team for further information.
- DO NOT operate the appliance continuously for more than 3 minutes. Allow the unit to cool completely before using again (whether making fruit desserts or salad).
- Kogan.com does not recommend the use of accessory attachments. Use of accessory attachments may cause injuries.
- DO NOT use outdoors. FOR HOUSEHOLD USE ONLY.
- Make sure the chute, grinder and dispenser are securely locked into place before operating.
- Use the plunger to force frozen fruit into the shaft. NEVER use your hands to force ingredients into the unit.
- Position the appliance as close to the electrical outlet as possible to prevent injuries due to people tripping over the cord.
- DO NOT place on or near a hot gas or electric burner, nor in a heated oven.
- Check unit for the presence of foreign objects prior to use.
- DO NOT use the appliance for anything other than its intended use.
- An appliance that is plugged into an outlet should not be left unattended while in operation.
- A short power supply cord is provided to reduce the risks resulting from becoming entangled or tripping over a long cord.
- Always disconnect the appliance from the power supply if the unit is being left unattended and before assembling, disassembling or cleaning.
- This appliance shall not be used by children. Keep the appliance and its cord out of reach of children.
- Appliances can be used by persons of reduced physical, sensory or mental capabilities or lack of experience and knowledge ONLY if they have been given supervision or instruction concerning use of the appliance in a safe way and they understand the hazards involved.
- Children should not play with the appliance.
- Check that the appliance is switched OFF before plugging the unit into a wall outlet. To disconnect, turn the switch of OFF, then remove the plug from the wall outlet.
- Do not let the cord hang over the edge of a table or counter top, or touch a hot surface.

Parts List

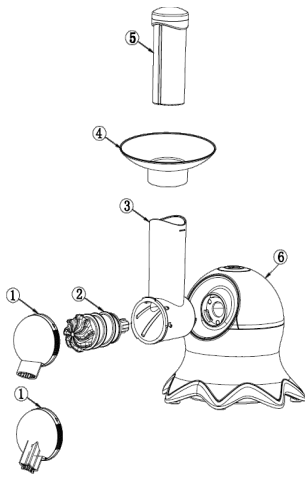

1. Dispenser
2. Grinder
3. Chute
4. Tray
5. Plunger
6. Base

Assembly

1

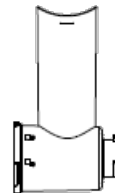
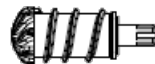

2

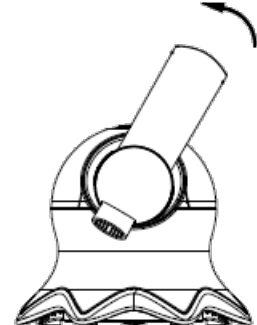
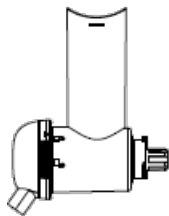

3

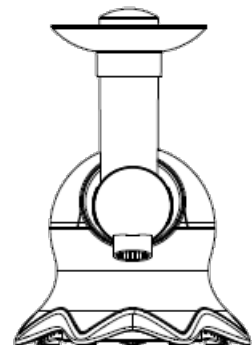
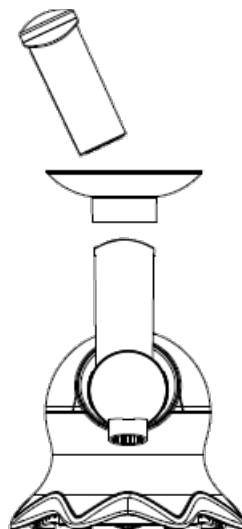
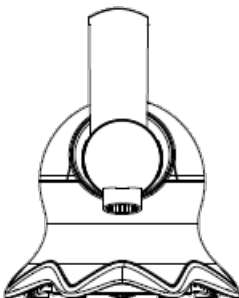

1. Insert the grinder into the chute, ensuring that the gasket is placed correctly inside the dispenser. Attach the dispenser to the chute by placing on the front and turning counter-clockwise to lock.
2. Insert the tip of the grinder into the base of the unit. Turn counter-clockwise to lock the chute assembly in place.
3. Insert the plunger into the chute.

Operation



1. Freeze your desired fruit for 24 hours.
2. Take frozen fruit from the freezer and let fruit partially thaw at room temperature for approximately 5-10 minutes.
3. Plug in the unit and place a small bowl below the dispenser.
4. Remove the plunger from the chute and insert frozen fruit slowly into the top of the chute. DO NOT overfill the chute and turn the unit ON.
5. Repeat with frozen chocolate, frozen cream or any other desired dairy products.
6. Apply steady pressure to the plunger to slowly press the ingredients down through the chute. DO NOT apply too much force to the plunger.
7. The creamy frozen fruit mixture will dispense into your bowl. You may choose to stir the frozen fruit before serving to ensure it is evenly mixed.
8. For hard ice-cream, please place into the freezer for over an hour, then serve.

Ingredients

Fruit should be frozen for a minimum of 12 hours before use.

The following frozen fruits work best:

- **Berries:** strawberries, blueberries, blackberries, raspberries, cranberries.
- **Bananas:** should be over-ripe and peeled before freezing. DO NOT freeze unpeeled bananas.
- **Melons:** Honeydew, cantaloupes, watermelon.
- **Pineapple:** peeled, cored and cut into long, thin strips.
- **Peaches, Pears, Apples, Mango**

If using a variety of fruits or berries per batch, add the different fruits alternately to allow them to mix properly and ensure proper consistency.

DO NOT place fruit with pits into the machine.

Recipes

MINT CHOCOLATE CHIP

Ingredients: 2 frozen ripe bananas, 1 oz mint dark chocolate.

1. Insert one frozen banana
2. Add 1oz dark mint chocolate
3. Insert second frozen banana
4. Stir in bowl to combine

LEMON RASPBERRY

Ingredients: 2 frozen ripe bananas, 1 tbsp lemon (zest of one lemon), $\frac{1}{2}$ cup frozen raspberries.

1. Insert one frozen banana
2. Add 1tbsp lemon zest
3. Add $\frac{1}{2}$ cup frozen raspberries
4. Insert second frozen banana
5. Stir in bowl to combine

PERFECTLY PEACH

Ingredients: $\frac{1}{2}$ cup peaches, $\frac{1}{4}$ cup frozen cantaloupe, $\frac{1}{4}$ cup frozen cream.

1. Insert $\frac{1}{4}$ cup frozen cantaloupe
2. Add $\frac{1}{8}$ cup frozen cream
3. Insert $\frac{1}{2}$ cup peaches
4. Add $\frac{1}{8}$ cup frozen cream

STRAWBERRY

Ingredients: 2 cups frozen strawberries, $\frac{1}{2}$ cup frozen cream, $\frac{1}{2}$ cup ice cube milk

1. Insert 1 cup frozen strawberries
2. Add frozen cream
3. Insert second cup frozen strawberries
4. Add ice cube

BLACKBERRY VANILLA BEAN

Ingredients: 2 vanilla beans, $\frac{3}{4}$ cup frozen blackberries, $\frac{1}{4}$ cup crushed pistachios, $\frac{1}{4}$ cup frozen cream

1. Split 2 vanilla beans lengthwise and scrape seeds from beans
2. Spread seeds over blackberries with a knife
3. Insert half of the frozen blackberries
4. Add $\frac{1}{4}$ cup of frozen cream
5. Insert remaining blackberries
6. Add $\frac{1}{4}$ cup of pistachios

TROPICAL TEASE

Ingredients: $\frac{1}{2}$ cup frozen pineapple chunks, $\frac{1}{2}$ cup frozen mango chunks, $\frac{1}{4}$ cup shredded coconut, $\frac{1}{4}$ cup frozen cream

1. Add $\frac{1}{2}$ cup of frozen pineapple
2. Add $\frac{1}{8}$ cup of frozen cream
3. Add $\frac{1}{2}$ cup of frozen mango chunks
4. Sprinkle shredded coconut on top of dessert in bowl

Cleaning & Maintenance

- Make sure the unit is unplugged before cleaning.
- Before first use and after each use, wipe unit clean with a damp cloth and dry thoroughly.
- Remove the plunger and chute.
- Turn the chute clockwise to remove from the base.
- Turn the dispenser clockwise to disassemble from the chute. Remove the grinder.
- Wash drip tray, chute, grinder, plunger and dispenser in warm, soapy water with a non-abrasive moist sponge or cloth. Dry thoroughly with a non-abrasive towel.
- Wipe the base with a damp, non-abrasive cloth and dry thoroughly. DO NOT immerse the base or cord in water or any other liquid.
- To prolong the life of the unit, hand-washing parts is advised. Dishwasher cleaning of accessories is not recommended. NEVER place the base in the dishwasher.
- Reassemble the unit and store in a dry, cool location until next use.

Troubleshooting

Problem	Cause/Solution
Soft-serve fruit mixture stops dispensing	The chute may be clogged. Turn the unit off IMMEDIATELY and unplug from the electrical outlet. Remove the dispenser by turning clockwise and take out the grinder. Wipe clean, then reassemble the unit.
Fruit is leaking out of the dispenser	Ensure that the gasket is attached to the dispenser correctly.
Ice-cream is coming out too soft	The fruit is not frozen enough. Put into freeze for several hours.