



Kogan Oslo Tabletop Stand for 32"-55" TVs KATVBKSTNDA Quick Start Guide

Safety & Warnings







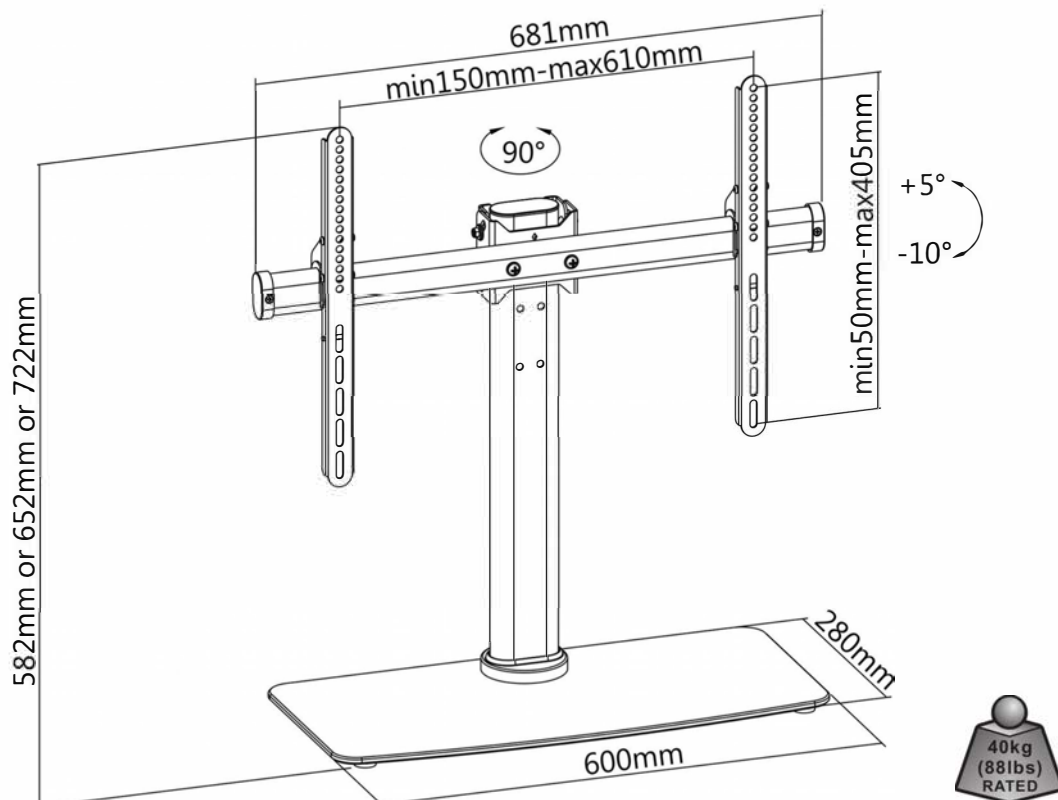

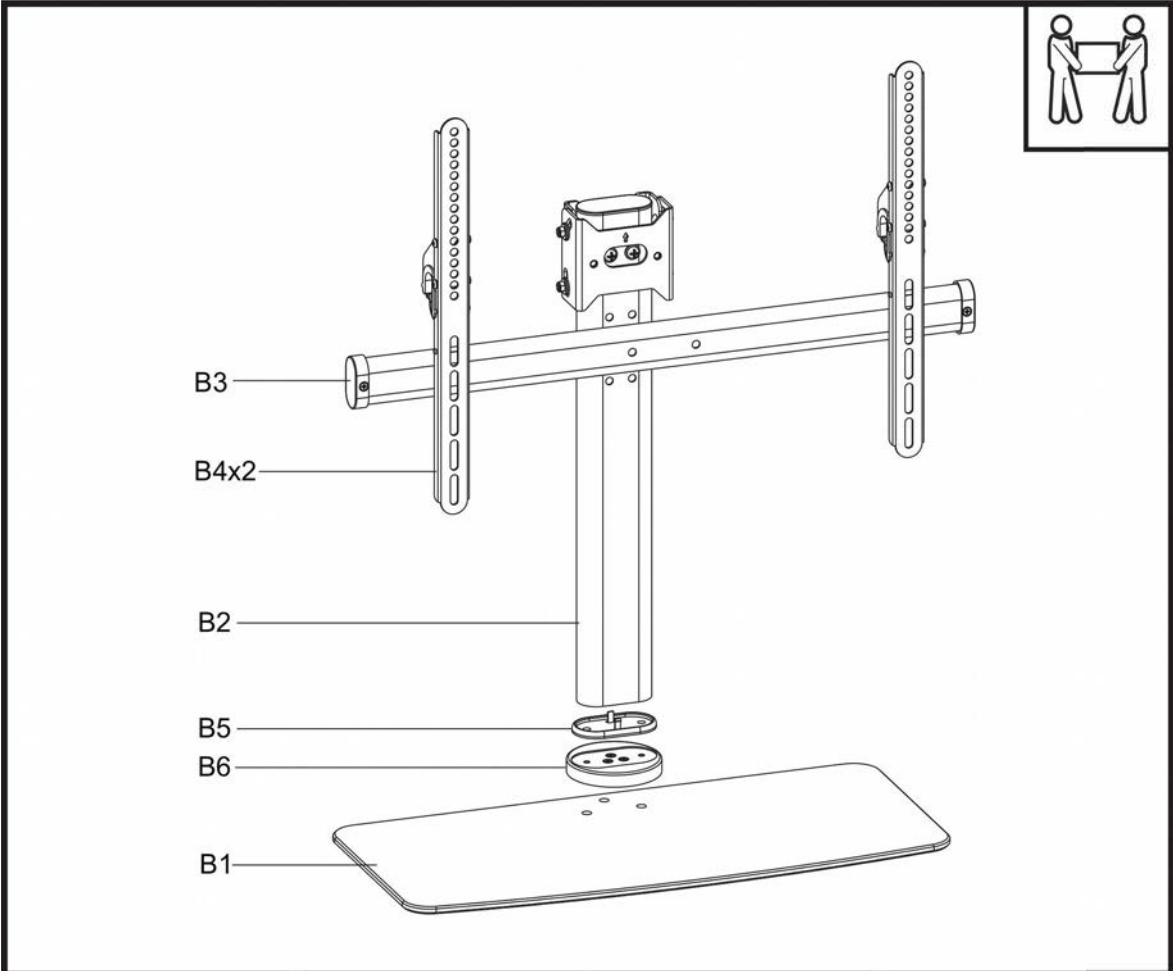









- Read all instructions before using the appliance and retain for reference.
- This appliance is not intended for use by persons (including children) with reduced physical, sensory or mental capabilities, or lack of experience and knowledge, unless they have been given supervision or instruction concerning use of the appliance by a person responsible for their safety.
- This product contains small parts which could pose a choking hazard if swallowed. Keep away from children.
- Pay close attention to the weight limits, ensure all connections are secure and ensure the screws, brackets and mounting points on any monitors are in good condition.
- Safety gear and proper tools must be used. This product should only be installed by professionals.
- This product is for indoor use only. Use outdoors may result in product failure, product damage and/or personal injury.

Maintenance

- Check the brackets are secure and safe to use at regular intervals (at least every three months).

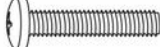
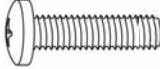
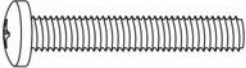



| | | | |
|--|--|---|--|
| A1x4  | A2x3  | A3x3  | A4x2  |
| A5x3  | A6x4  | A7x2  | A8x2  |
| A9x2  | A10x1  | A11x1  | A12x2  |
| M5x14 (x4) M-A  | M6x14 (x4) M-B  | M6x30 (x4) M-C  | M8x30 (x4) M-D  |
| M8x50 (x4) M-E  | (x4) M-F  | (x8) M-G  | (x8) M-H  |

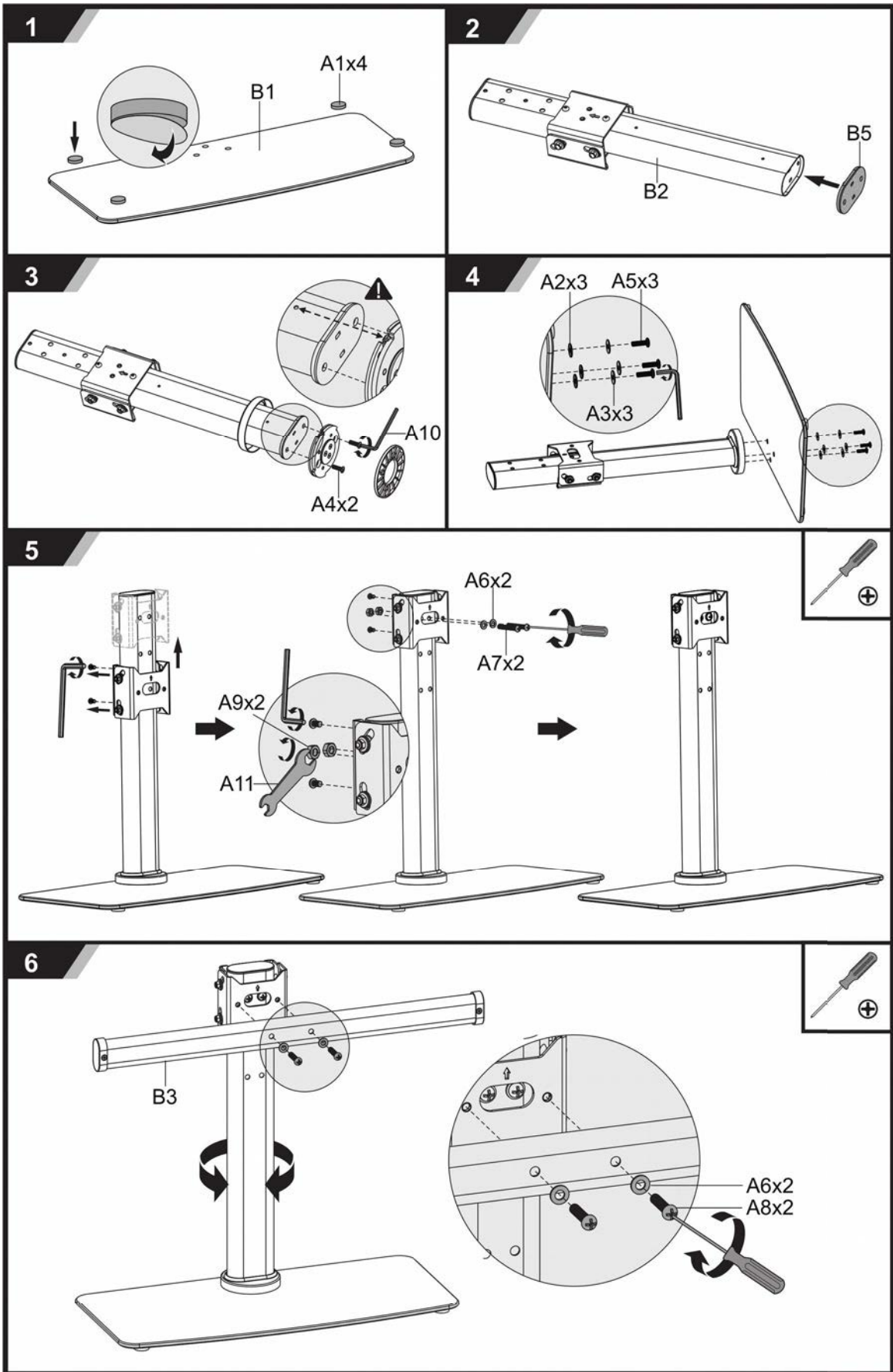

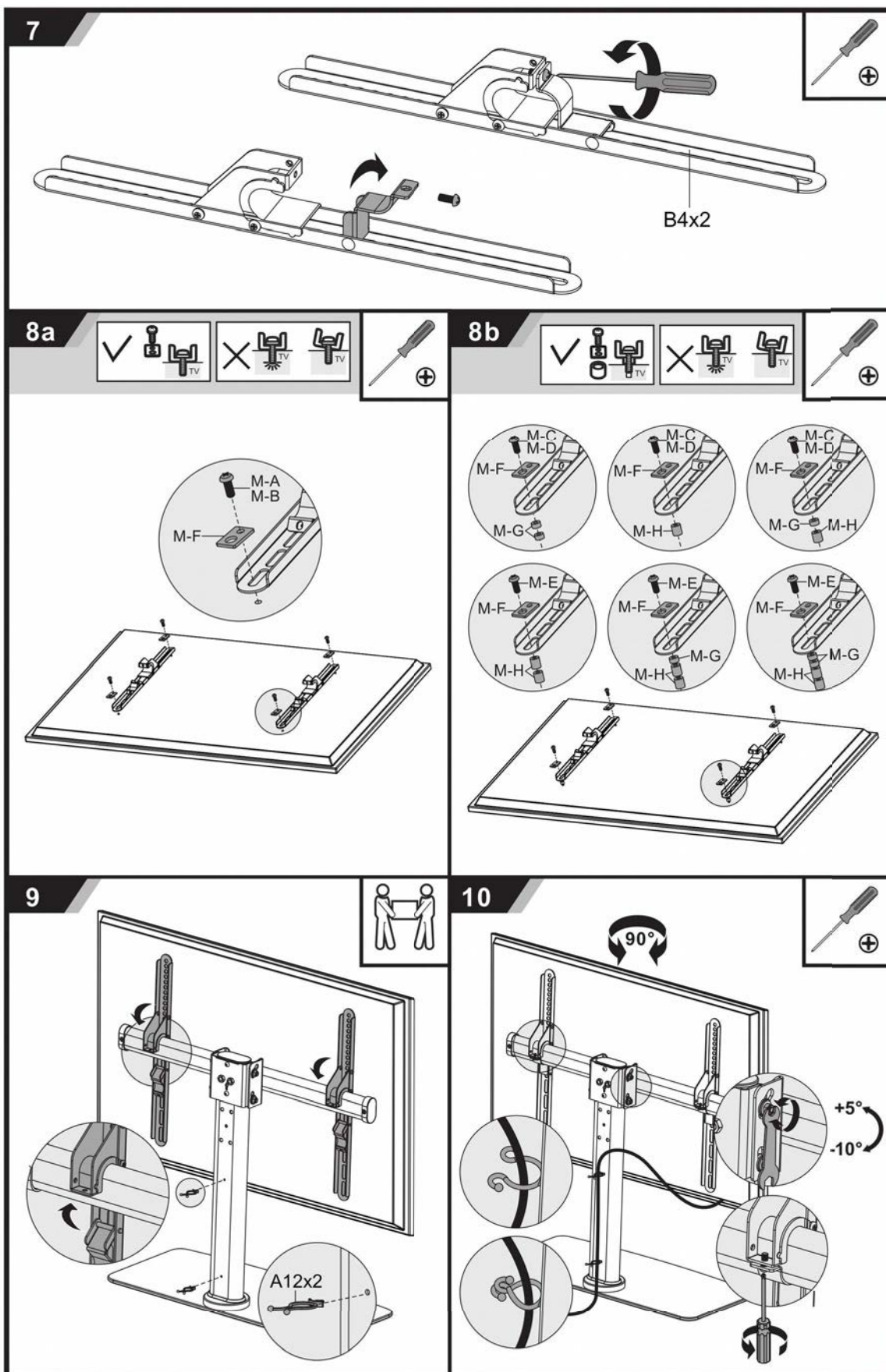

User manual is subject to change without notice. For the latest version of your user manual, please visit <https://www.kogan.com/usermanuals/>