



ARNE DINING CHAIR

User Guide

MATT BLATT

MBARNE2DCAA, MBARNE2DCBA,
MBARNE2DCGA, MBARNE2DCNA

COMPONENTS

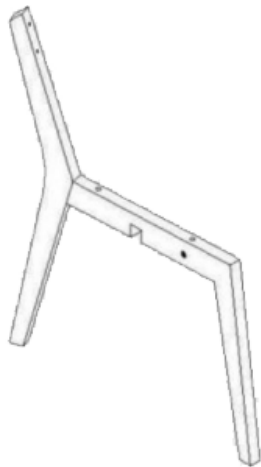

A (x1)



B (x1)



C (x1)

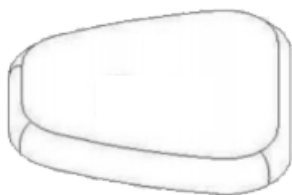

D (x1)

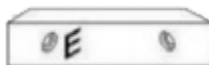

E (x2)

HARDWARE



1 (x4)



2 (x4)



3 (x4)



4 (x4)



5 (x1)



6 (x4)

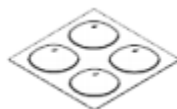

7 (x1)

ASSEMBLY

Step 1

Assemble wooden frame/legs "A" and "B" together.

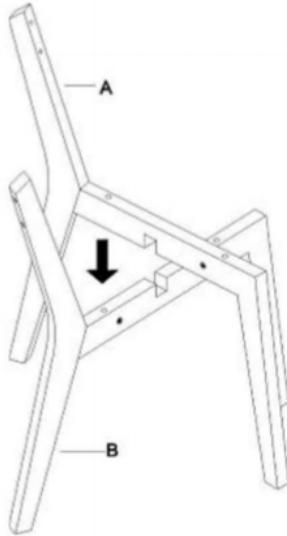

Step 2

Using the Allen Key (5), Attach Side Rail (E) to each side of the assembly with screws (1).

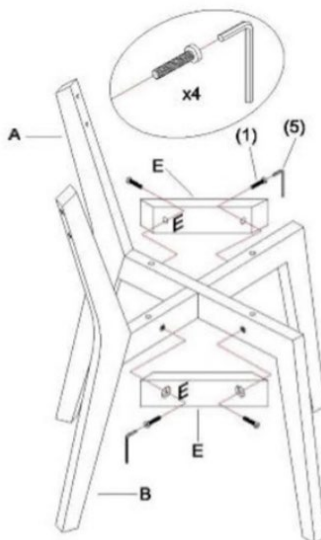

Step 3

Using the Allen key (5), attach Backrest (C) to the assembly with screws (2).

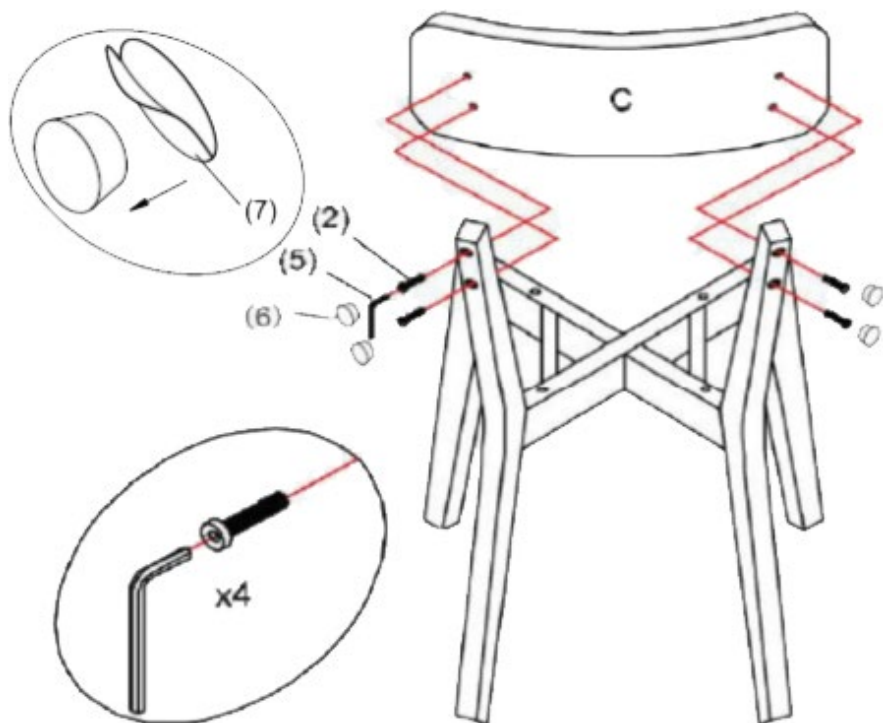

Note:

Do not fit the wooden plugs (6) at backrest of chair until after assembly is complete. Tighten all screws to 80% strength, then retighten when assembly is complete. Only fit wooden plugs (6) once tightened fully.

Step 4

Using the Allen key (5), Attach Seat (D) to the assembly with washers (4) and screws (3).

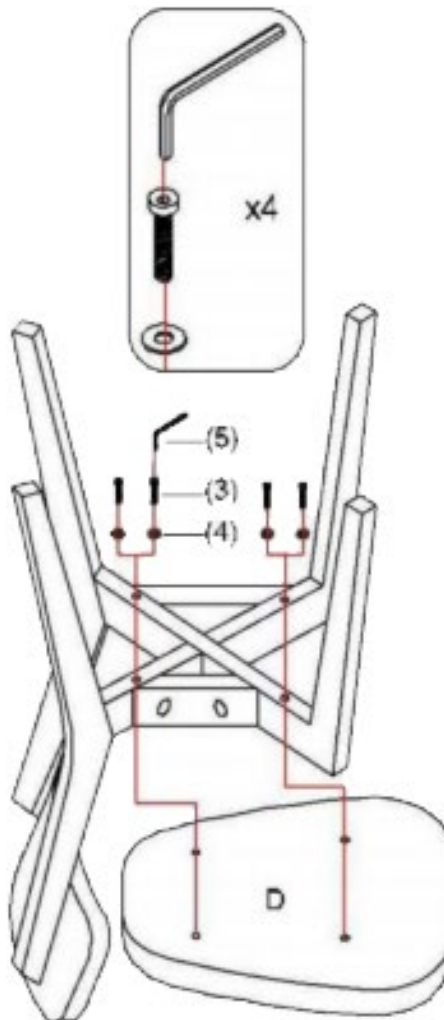

Assembly is now complete. Tighten all screws and fit wooden plugs (6) and floor protectors (7).



Complete!

NEED MORE INFORMATION?

We hope that this user guide has given you the assistance needed for a simple set-up. For the most up-to-date guide for your product, as well as any additional assistance you may require, head online to **help.mattblatt.com.au**

MATT BLATT