



SPENCER DINING CHAIR

User Guide

MATT BLATT

MBSPC2DDGA, MBSPC2DLGA

COMPONENTS



1. Chair Body

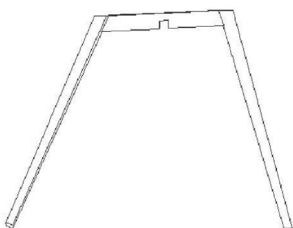

2. Base (x2)



3. Brackets (x2)

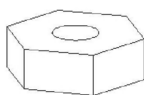

4. Nuts (x4)

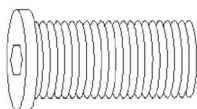

5. M6x40 (x4) Screws

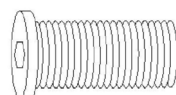

6. M6x45 (x4) Screws



7. Washers(x12)

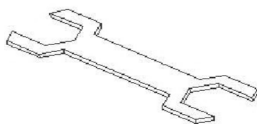

8. Spanner key



9. Allen key

ASSEMBLY

Step 1

Using the Allen key and Spanner key, attach the two Base (2) assembly pieces, with one Bracket (3) piece above and beneath the assembly.

Ensure the longer half of each base (45cm) are positioned on the same side.

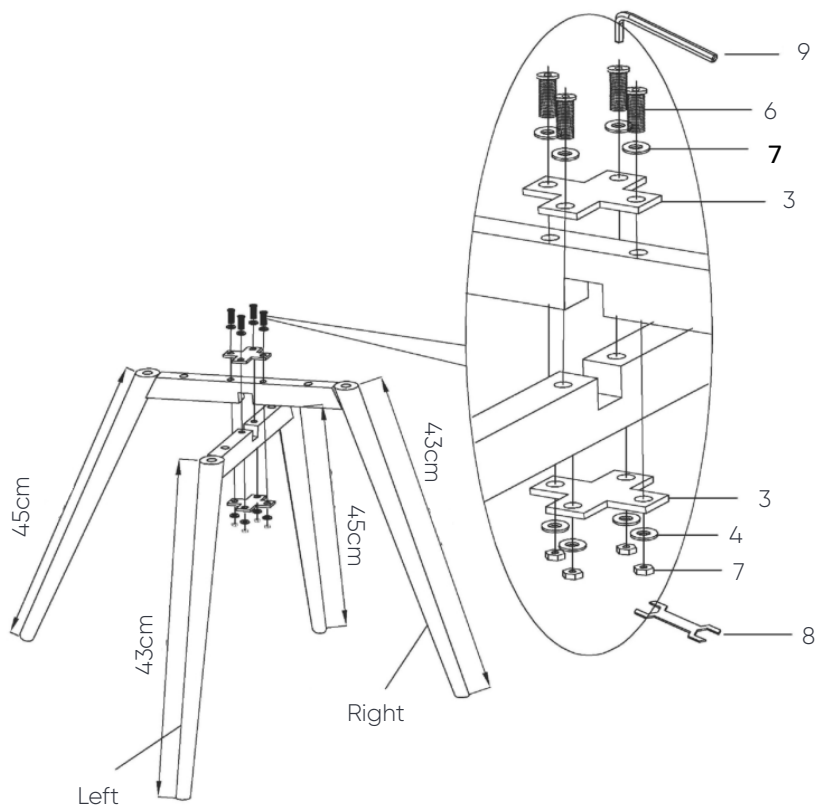

Step 2

Align the chair body to the Base with the screws

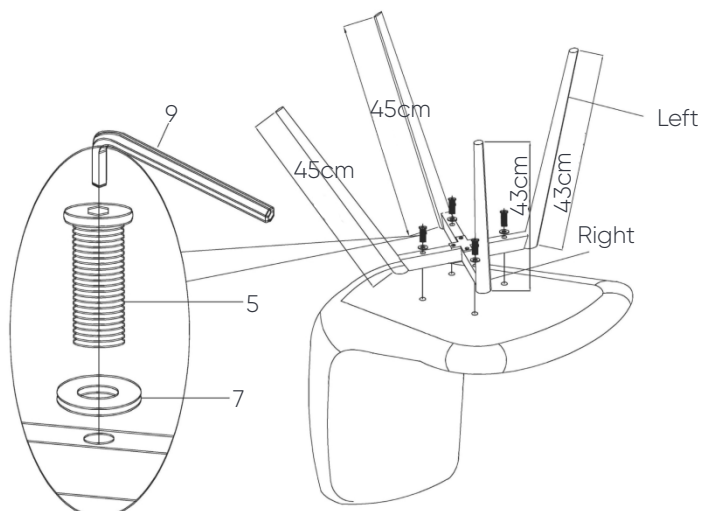

Step 3



Completed

CARE & MAINTENANCE

Regular Care

- Rotate reversible cushions regularly
- Protect from direct sun light
- Do not wash dry clean

Do Not Expose: to direct sunlight or heat as this may lead to fading or discolouration. Salts and body oils that occur naturally in the skin can damage the surface of the material, so make sure it is wiped over regularly with a clean, soft, colour-fast cloth dampened with water.

Do Not Use: saddle soap, detergents, solvents, abrasives, or any other products containing silicones or solvents.

Spot Cleaning: Use recognises upholstery cleaner. Before using, check effect of colour fastness on inconspicuous area and check effect on upholstery filling.

Important: Treat stains immediately.

To remove dust crumbs, vacuum lightly with appropriate cleaning accessory.

Note: Furniture must be vacuumed regularly using low suction to remove dust and dirt.

NEED MORE INFORMATION?

We hope that this user guide has given you the assistance needed for a simple set-up. For the most up-to-date guide for your product, as well as any additional assistance you may require, head online to **help.mattblatt.com.au**

MATT BLATT