









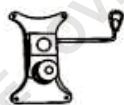

OVERDRIVE®Executive Racing Office Chair
Assembly Guide

Included Items

Part ID	Image	Name	Qty.
A		Wheel	5
B		Base Frame	1
C		Adjustable Gas Stem	1
D		Stem Cover	1
E		Adjustable Lever	1
F		Short Screw (M6 x 20mm)	4
G		Long Screw (M6 x 25mm)	8
H		Arm Rest	2
I		Seat Base	1
J		Back Support	1
K		Cap	8

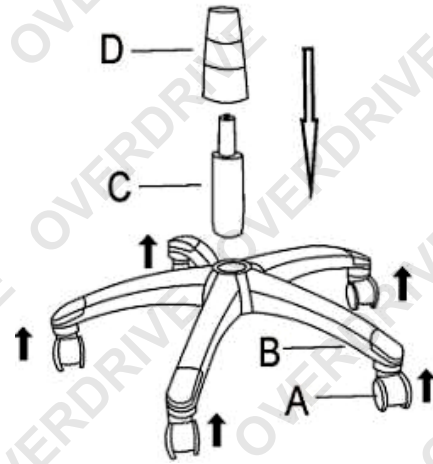

Step 1: Attach wheels to base frame and then adjustable gas stem to base frame.

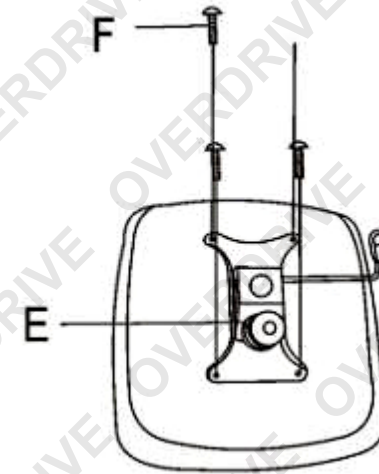

Step 2: Attach the adjustable lever to the seat base with short screws.

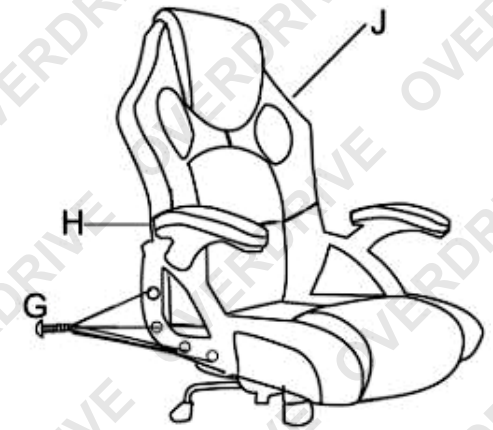

Step 3: Attach the arms to the seat base first using the long screws and then attach the back support to the arms using the same long screws.

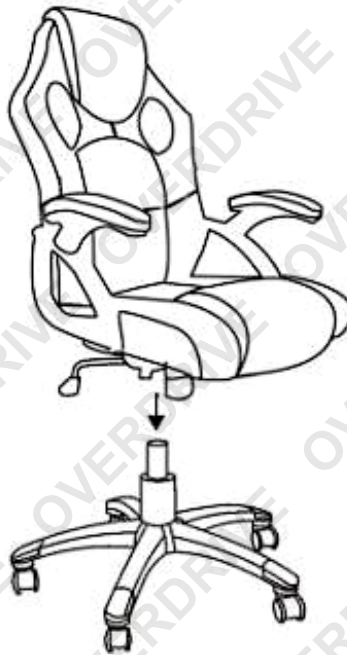

Step 4: Attach the seat assembly to the adjustable gas stem.



Step 5: Place the caps over the screw holes



Step 6: Ready to ride! *This is just an expression. Do not actually ride this as it's designed only for seating.*