

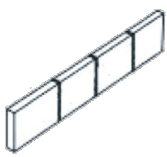







ovela









Faux Leather King Size Bed Frame (Vertical Columns) OVBEDFL1KNA / OVBEDFL1KNWA

Parts List

Body parts

		
1 - Headboard (1 pc)	2 - Footboard (1 pc)	3 - Side Rail (2 pcs)
		
4- Double Plastic Cap (26 pcs)	5 - Center Support Bar (2 pcs)	6 - Support Leg (4 pcs)
		
7 - Slats (39 pcs)	8 - Single Plastic Cap (26 pcs)	9 - Leg (4 pcs)

Hardware

			
A - M8x30mm Bolt (16 pcs)	B - M8x35mm Bolt (8 pcs)	C - M8x13mm Nut (8 pcs)	D - Spring Washer (8 pcs)
			
E - Flat Washer (12 pcs)	F - M5 Allen Key (1 pc)	G - Spanner (1 pc)	H - M8x70mm Bolt (4 pcs)

Fixing Legs to Headboard and Footboard

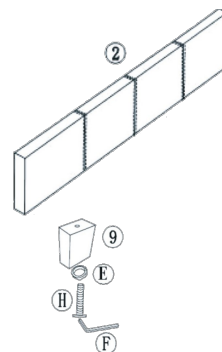
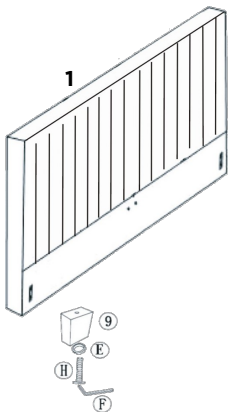

Fixing Support Legs to Centre Support Bar

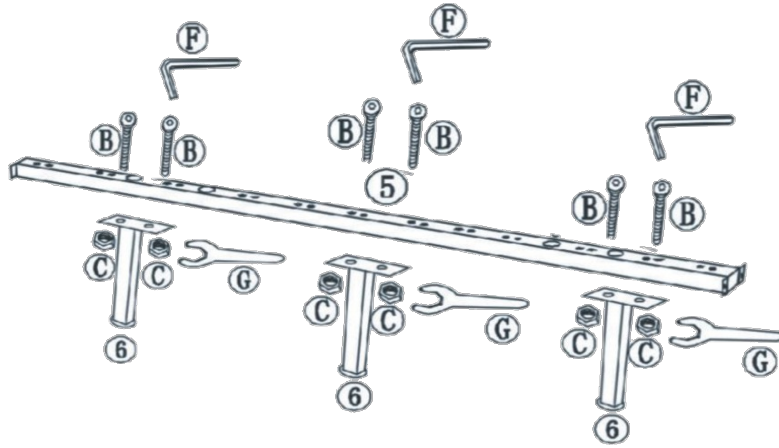

Fixing Rails and Support Bar to Headboard and Footboard

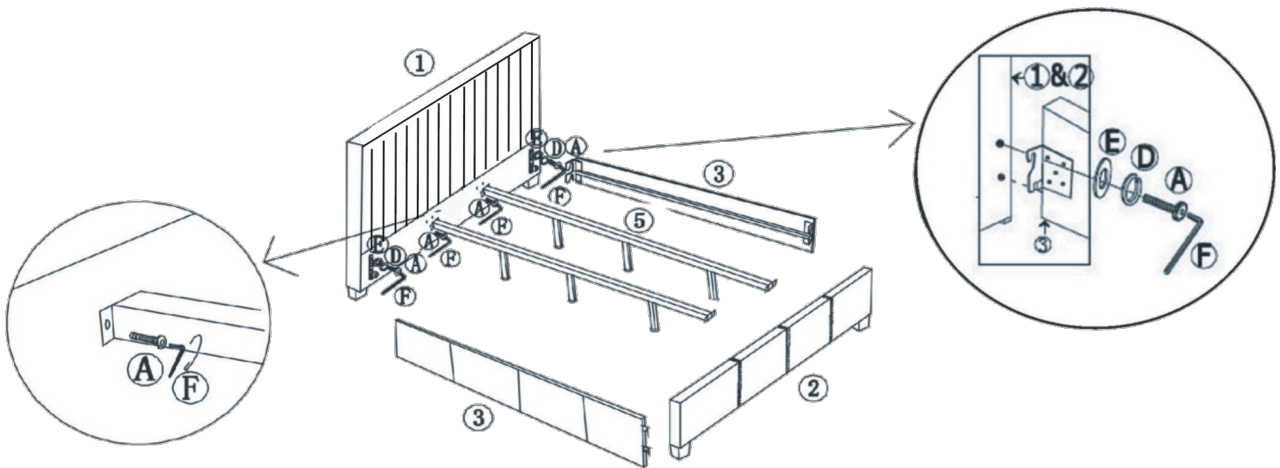

Fixing Plastic Caps and Slats

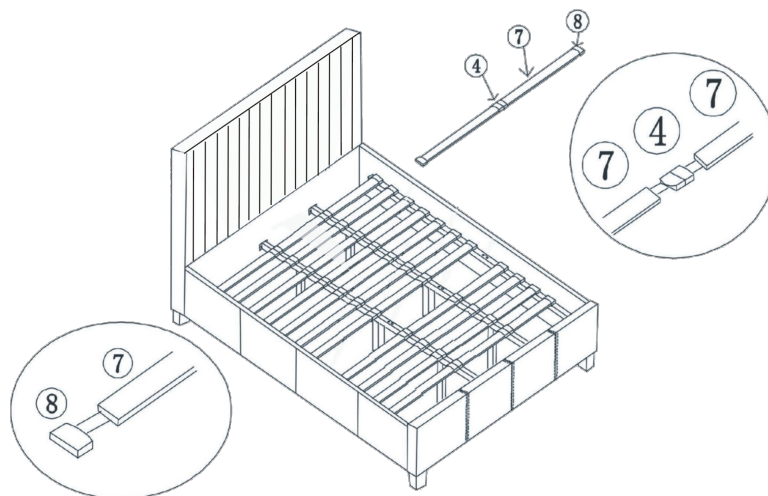

If you have any questions, please contact the Kogan customer support team.