

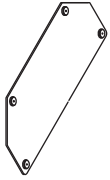

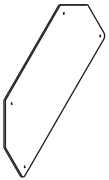

Assemble Instruction Manual

Model# : ACE900

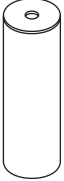

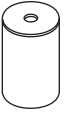
www.tauris.com.au

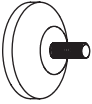
Part List	
A	 1 pcs
B	 2 pcs
C	 4 pcs
D	 4 pcs
E	 4 pcs
F	 4 pcs
G	 4 pcs

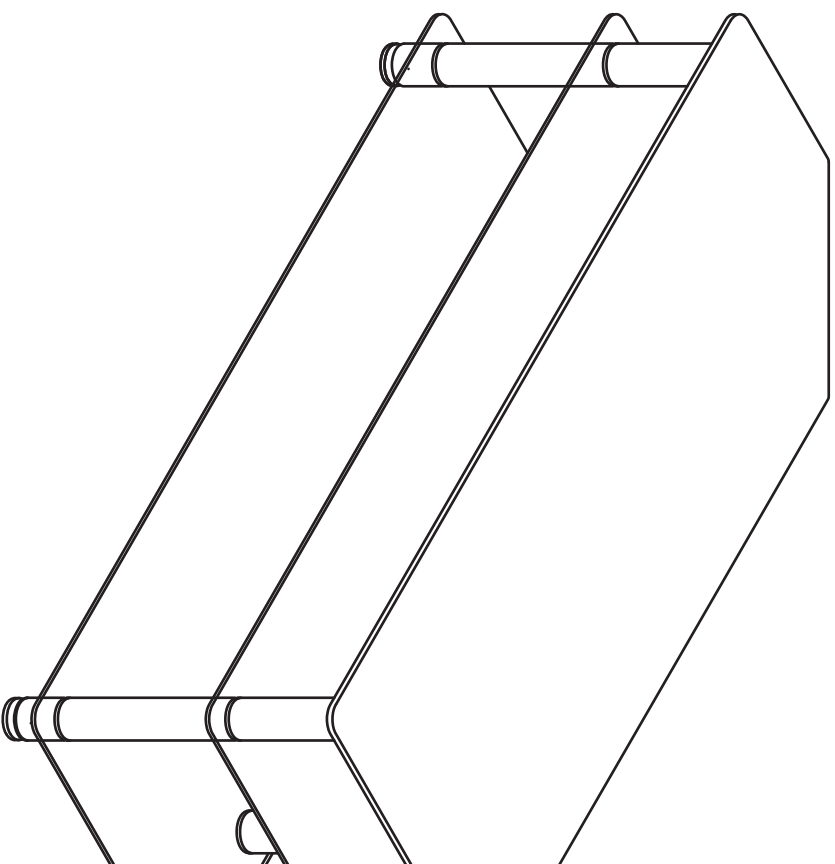

GUIDE TO ASSEMBLY

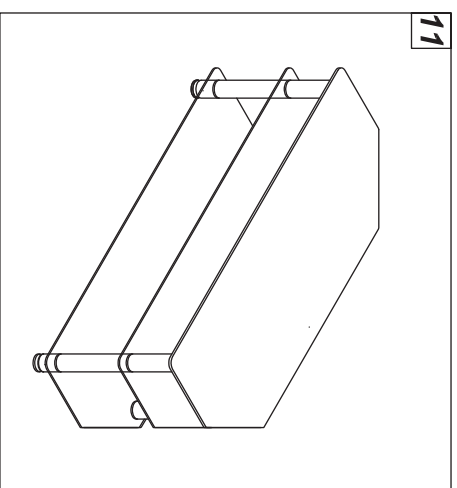
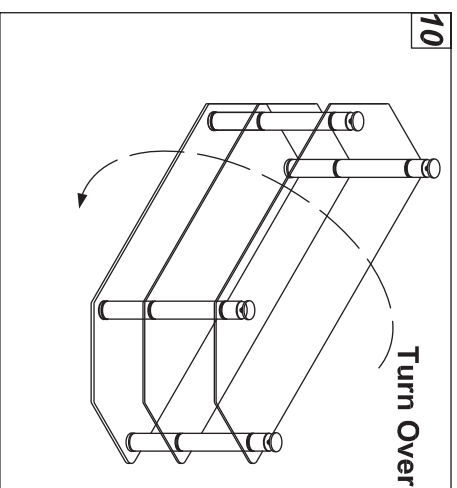
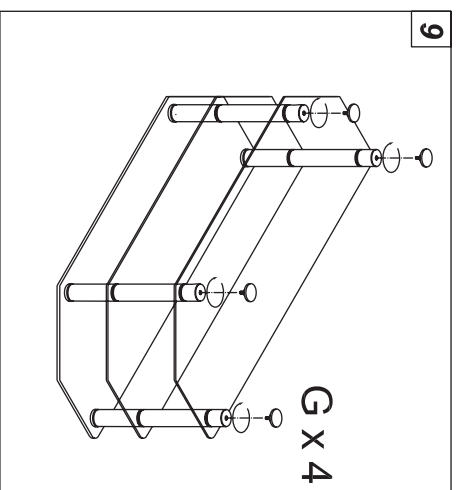
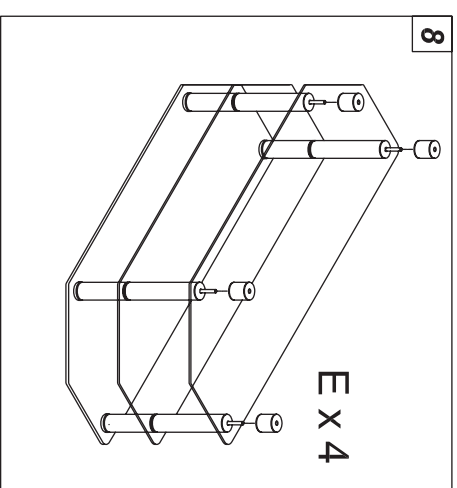
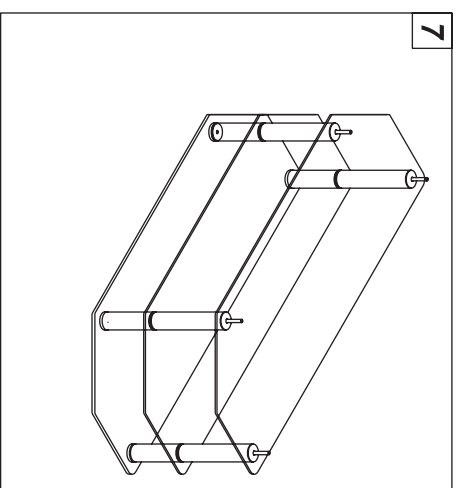
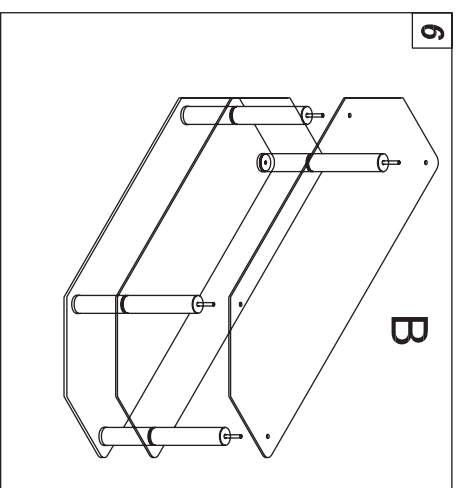
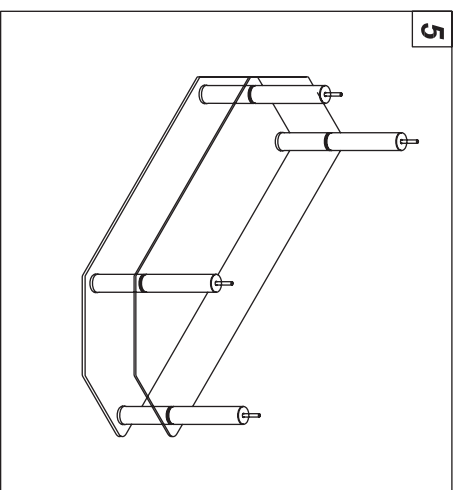
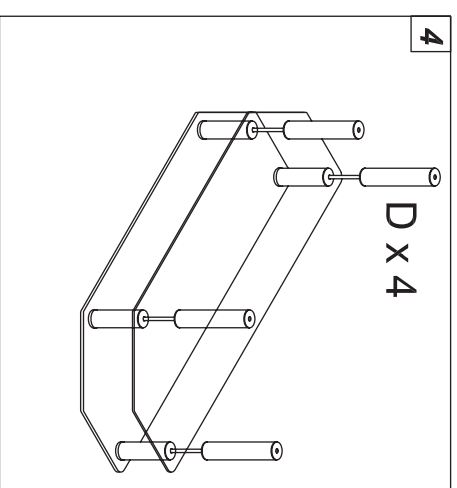
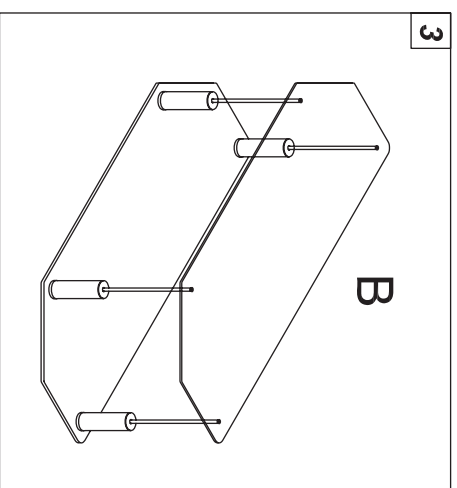
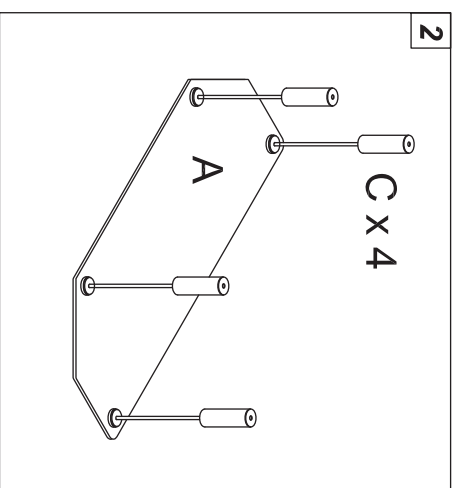
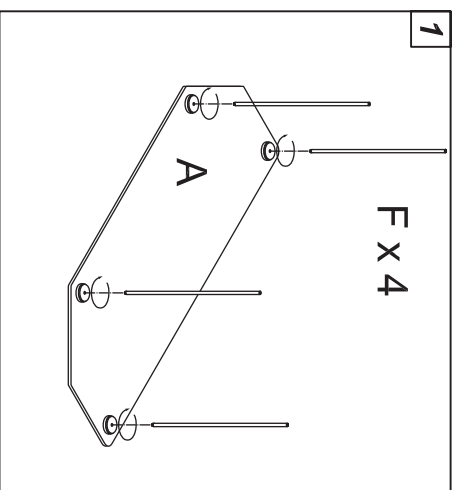



EXTENDED WARRANTY & POLICY

1. Nothing in this Warranty affects the Consumer's rights under the Australian Consumer law. The benefits to the Consumer under this Warranty are in addition to the rights and remedies of the buyer under any Consumer Guarantees. The Australian Consumer Law requires that we confirm that:

Our goods come with guarantees that cannot be excluded under the Australian Consumer Law. You are entitled to a replacement or refund for a major failure and for compensation for any other reasonably foreseeable loss or damage. You are also entitled to have the goods repaired or replaced if the goods fail to be of acceptable quality and the failure does not amount to a major failure.

2. Subject to Clause 1, the Seller warrants that **Tauris** branded products will be free of manufacturing defects and will perform to the Seller's specifications subject to the following clauses.
3. The benefit of this Warranty extends only to the owner of the property in which the products manufactured or supplied by the Seller are installed, assembled and /or used by the owner for the duration of the Warranty Period.
4. The Warranty commences on the date of the purchase of the product and continues for the benefit of the Owner for the Warranty Period. If within the Warranty period a manufacturing defect is discovered in the Product, or the Product fails to perform to the Sellers specifications as a result of some defect in material or workmanship in the Product, then the Seller will at its own discretion:-
 - a.) Repair or replace the Product at the cost of the Seller, including but not limited to labour and travel costs. Goods repaired or replaced under this Warranty will be warranted for the remaining period of the Warranty.
 - b.) Refund the purchase price paid by the consumer.
5. The Warranty does not apply to Product that :
 - a.) Has failed due to excessive wear and tear beyond what is considered to be reasonable.
 - b.) Was installed, repaired or maintained by any person other than a qualified tradesperson.
 - c.) Has been misused or neglected.
 - d.) Was been damaged accidentally or by acts of God including fire and flooding.
 - e.) Has been used or operated contrary to operating or maintenance instructions.
 - f.) Was incorrectly assembled or installed.
 - g.) Has been damaged due to faulty or incorrect wiring, incorrect power supply or voltage fluctuations.
 - h.) Has been damaged in transit from the Sellers store to the buyer, either by the buyer or a third party authorised to act for the buyer.
6. In order to make a claim under the Warranty, the Owner must, where possible return the goods to the Sellers store at the owners cost. Proof of purchase must be supplied in all cases.
7. The seller will examine any returned Products and if the Seller determines that there is an apparent defect through no fault of the Owner, the Seller will:
 - a.) Make note of the Owners contact details including the Owners telephone number which the owner can be contacted during business hours, postal address and e-mail address.
 - b.) Make note of the defects reported by the Owner.
 - c.) Take back the defective goods from the Owner and determine within a reasonable time through dialogue with the Seller whether the goods are defective.