

SHANGRI-LA

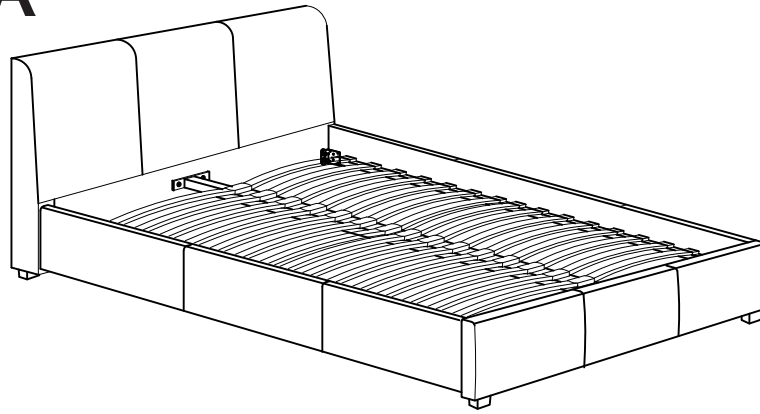







ASSEMBLY INSTRUCTIONS



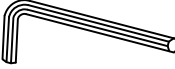

Tools Needed
2 person build



BED FITTINGS

				
Feet	Screws(M8*50)	Gold Bolts (m8*18)	Allen key (m5)	Bolts (m8*25)
① X 4	② X 8	③ X 8	④ X 1	⑤ X 6
				
Washers (m8)	Support legs	End plastic cap(Big)	End plastic cap(Small)	Slats
⑥ X 6	⑦ X 2	⑧ X 14	⑨ X 28	⑩ X 28

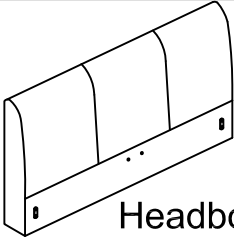
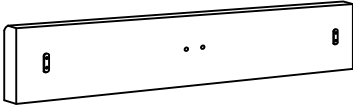
PART LIST

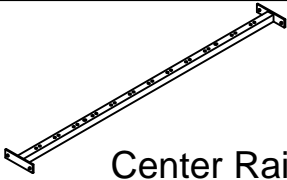
	
Headboard	Footboard
A X 1	B X 1
	
Side Rails	Center Rail
C X 2	D X 1

Step 1

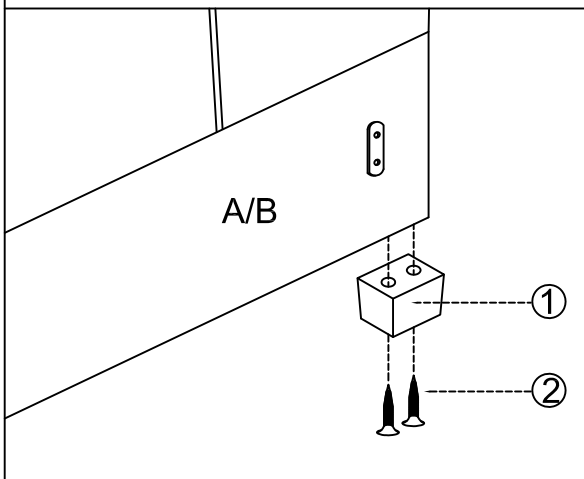

Step 2

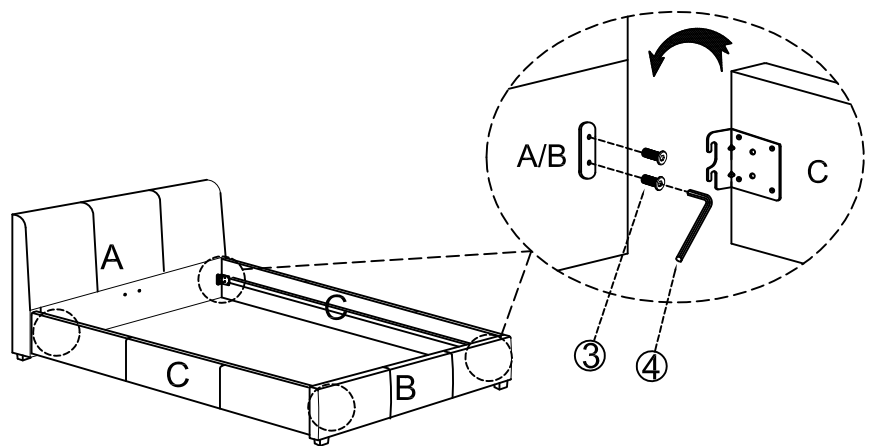

Step 3

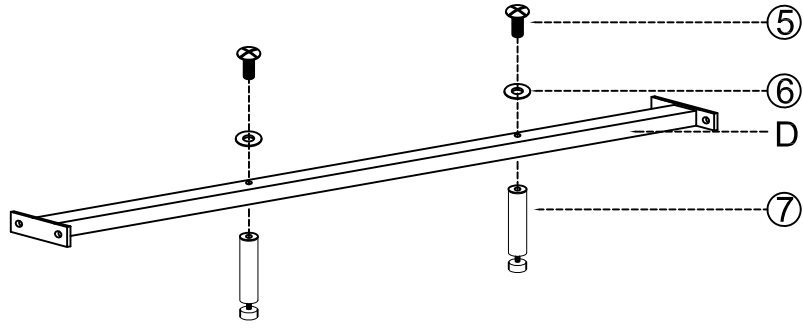

Step 4

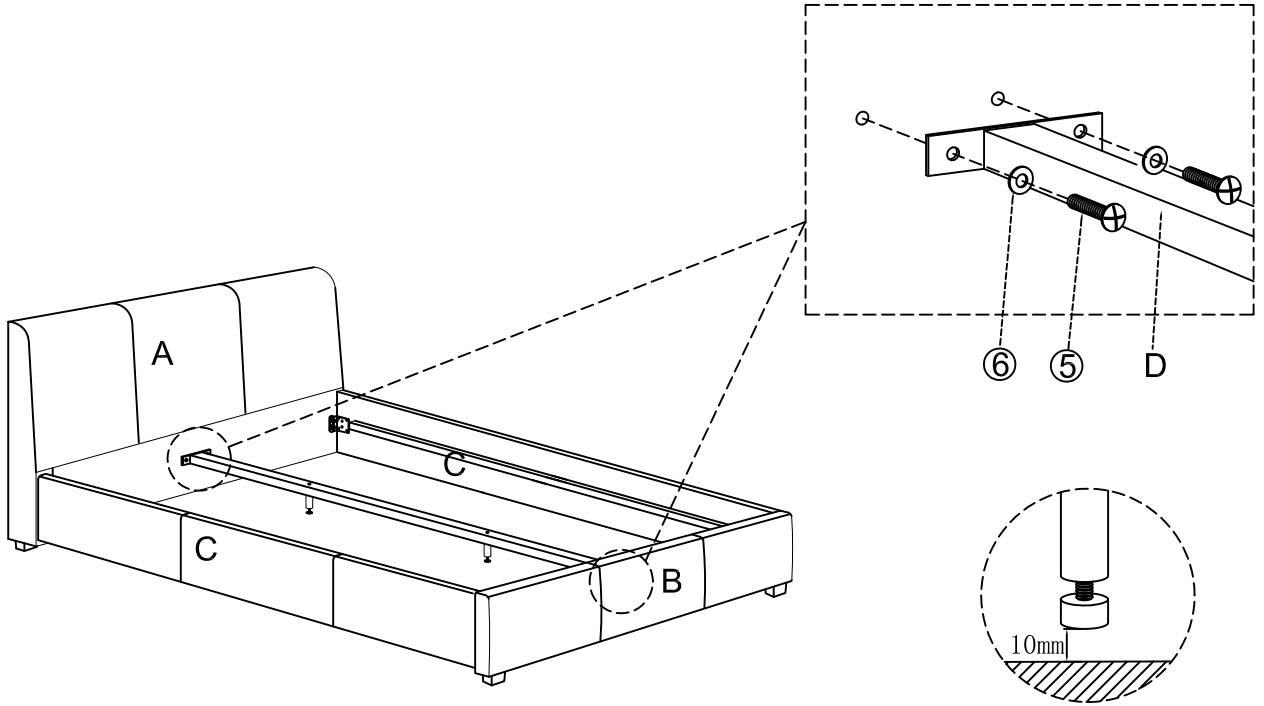

Step 5

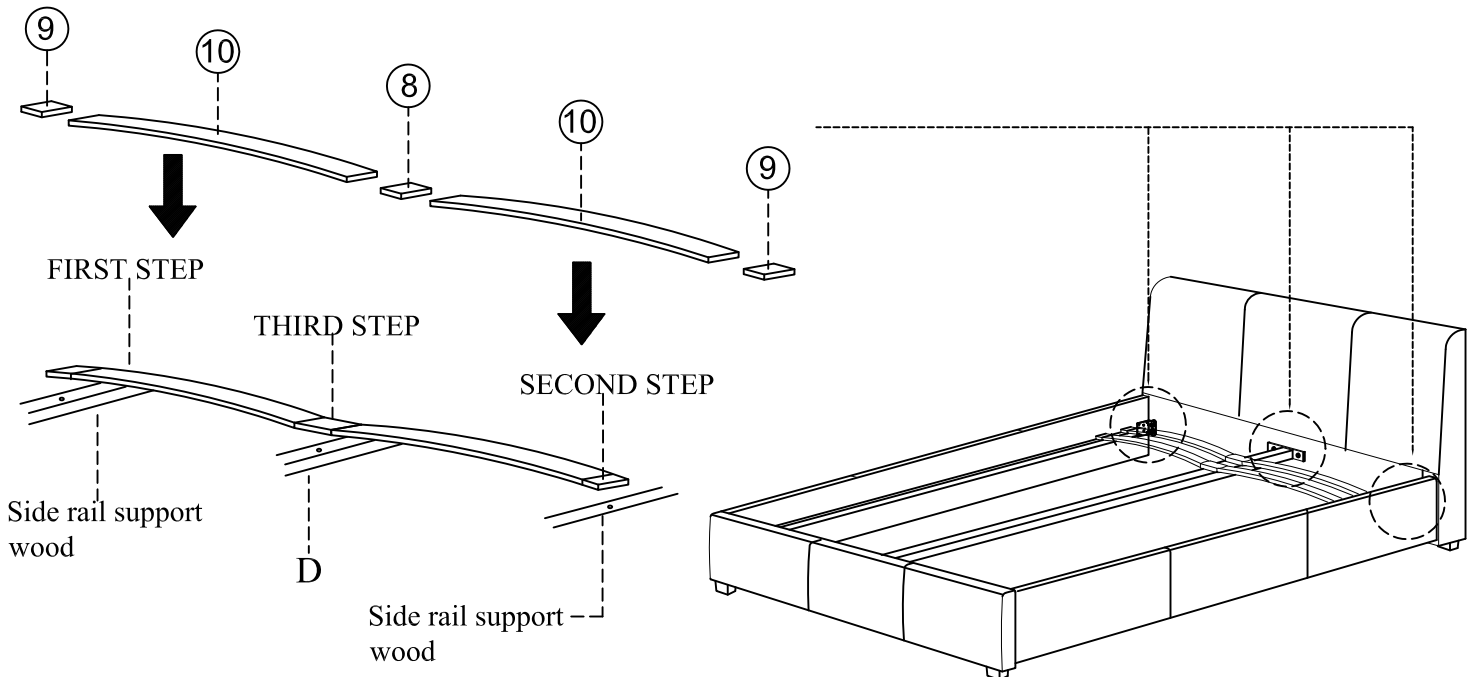

REMARK : ONCE BED IS ASSEMBLED, **DO NOT** SIT, STAND OR APPLY WEIGHT DIRECTLY TO SLATS UNLESS MATTRESS IS IN PLACE.